

# 10. EXPLODED VIEW AND PART LIST

## 10-1. THE PART LIST OF CABINET ASSEMBLY

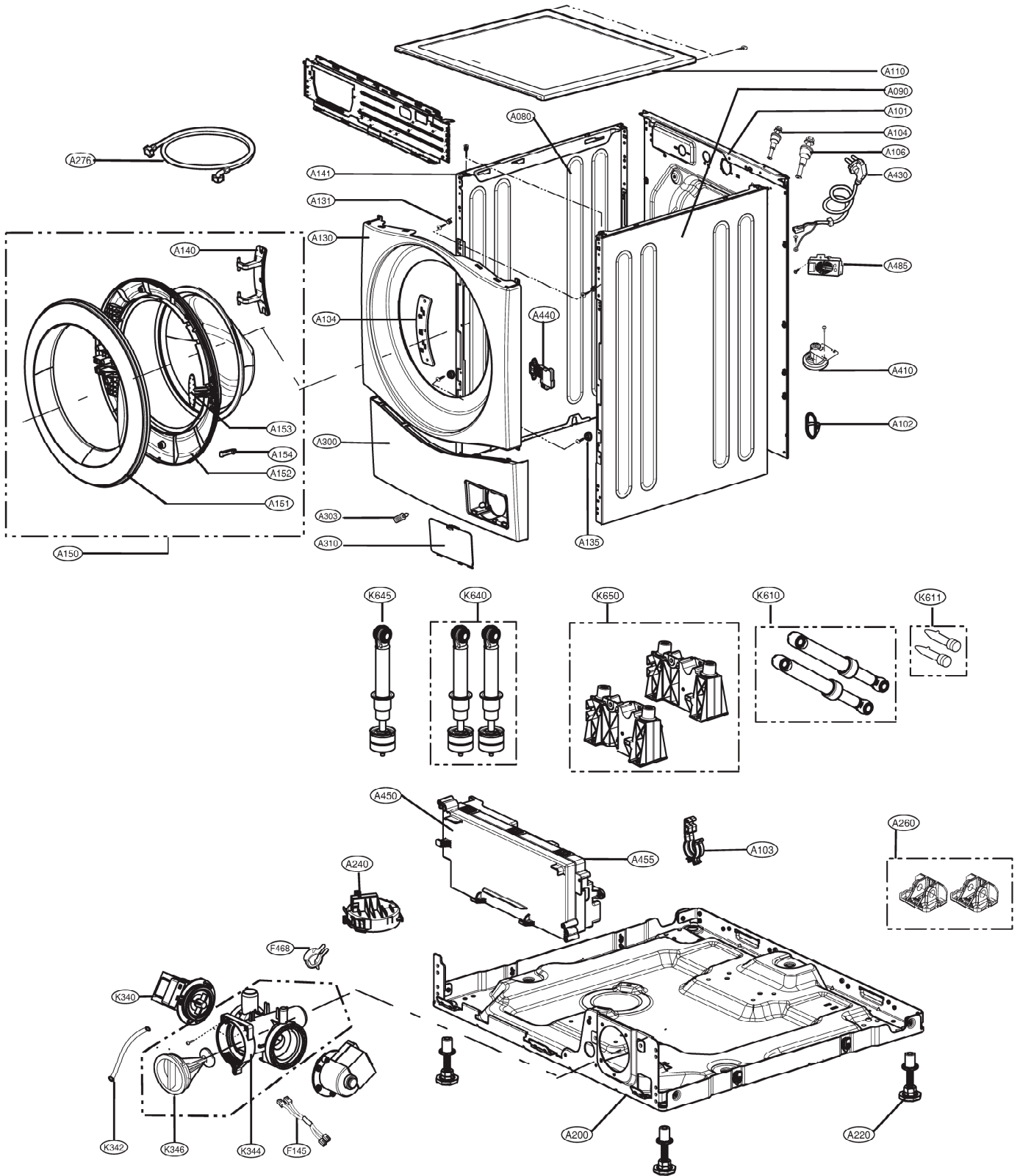

## 10-2. THE EXPLODED VIEW OF CONTROL PANEL & DISPENSER ASSEMBLY

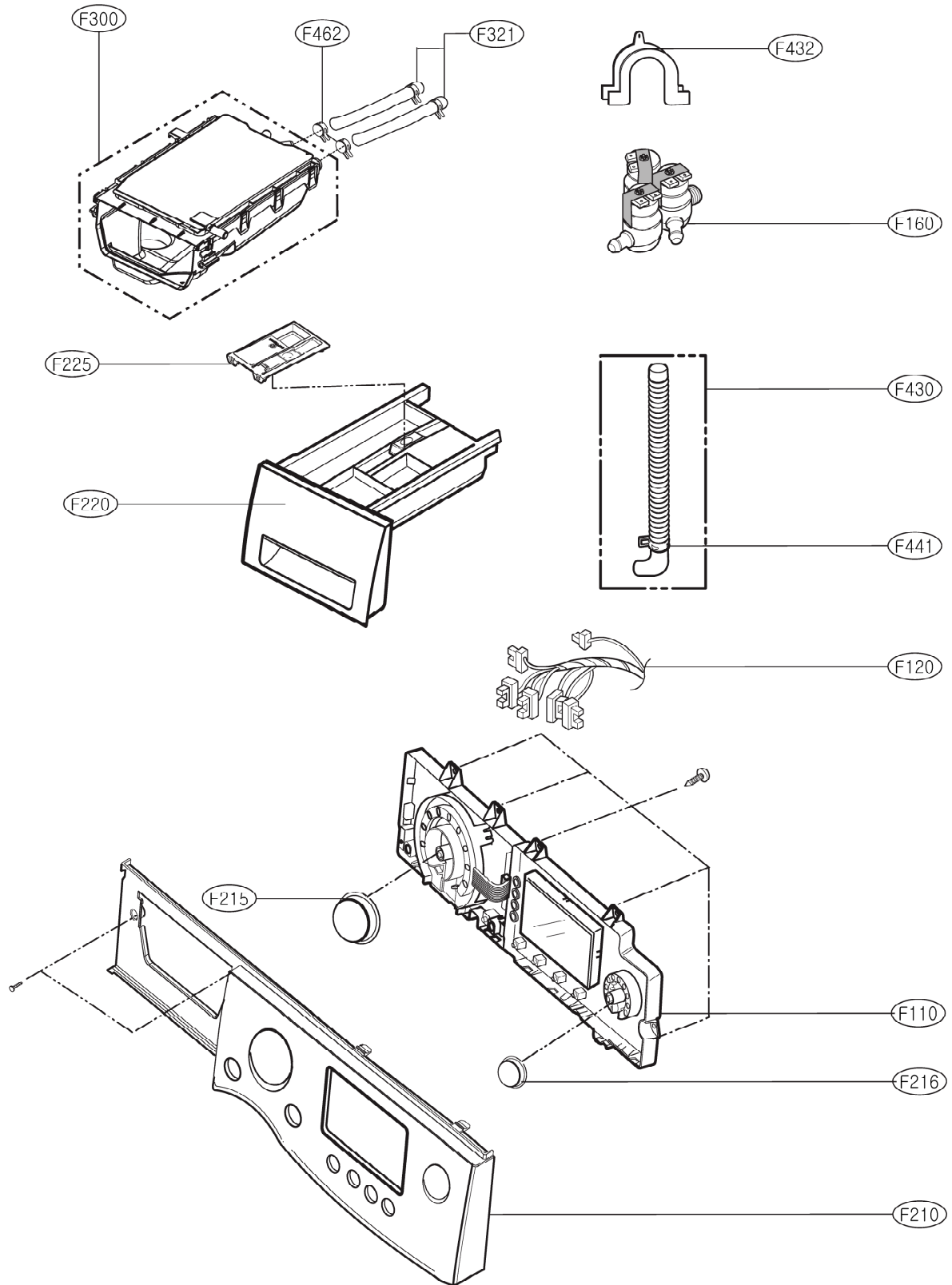

# 10-3. THE EXPLODED VIEW OF DRUM & TUB ASSEMBLY

