

S/M No. : DUD1213001

Service Manual

Drum Washing Machine

Model: D-UD1213EPB

DAEWOO

✓ **Caution**

: In this Manual, some parts can be changed for improving, their performance without notice in the parts list. So, if you need the latest parts information, please refer to PPL(Parts Price List) in Service Information Center (<http://svc.dwe.co.kr>).

DAEWOO 
ELECTRONICS

Apr. 2008

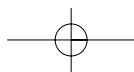

DRUM WASHING MACHINE SERVICE MANUAL

1. WHAT IS DRUM?	1
2. WASHER SPECIFICATION	4
3. OPERATING MECHANISM DIAGRAM.....	6
4. EACH PART OF DRUM WASHING MACHINE	8
5. PARTS LIST BY ASS'Y	10
6. CONTROL PART FUNCTION SPECIFICATION	25
7. ELECTRONIC FIELD PARTS LIST AND SPECIFICATION	49
8. WIRING DIAGRAM	76
9. TROUBLE SHOOTING REGARDING DRAIN	77
10. INSTALLATION	78
11. ATTENTION POINT WITH SERVICING	80

1. WHAT IS DRUM WASHING MACHINE?

1. Drum Washing Machine

Water consumption is reduced by using the power of the laundry falling (free-fall) created when rotating the drum. With temperature control system, this drum washing machine saves energy and improves washing performance at the same time.

2. Key Features

- ◆ **Waist Care**
Designed by the waist, and the most comfortable angle eject into the laundry is convenient and easy to manipulate.
- ◆ **The World's First Steam White Course**
The Steam White Course save more 50 percent of Electricity, Water, Time than previous White Course.
- ◆ **Star Drum**
Using Star Drum is able to higher Washing Performance and Minimal damage of laundry, water consumption.
- ◆ **The biggest capacity with compact size**
12 Kg Capacity enable to wash bigger laundry.
- ◆ **Simultaneous supply of cold and hot water**
As cold and hot water is supplied at the same time heating time and energy is saved.
- ◆ **Luxury Audio Dial**
Using the advanced Audio Dial is luxury design of exterior.
- ◆ **The World's First Shoes Course Enable to wash shoes.**
- ◆ **DD inverter motor**
The direct-drive type of which motor is directly connected to drum without an interim chuth, significantly reduces noise and vibration.
- ◆ **Self-Cleaning Course of Drum.**
Enable to Self-Cleaning of Drum.
- ◆ **Digital Condensing Dry System.**
Condensing Dry System with saveing energy.
- ◆ **For pump drainage, the powerful pump speeds up drainage process.**

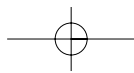

3. Power System

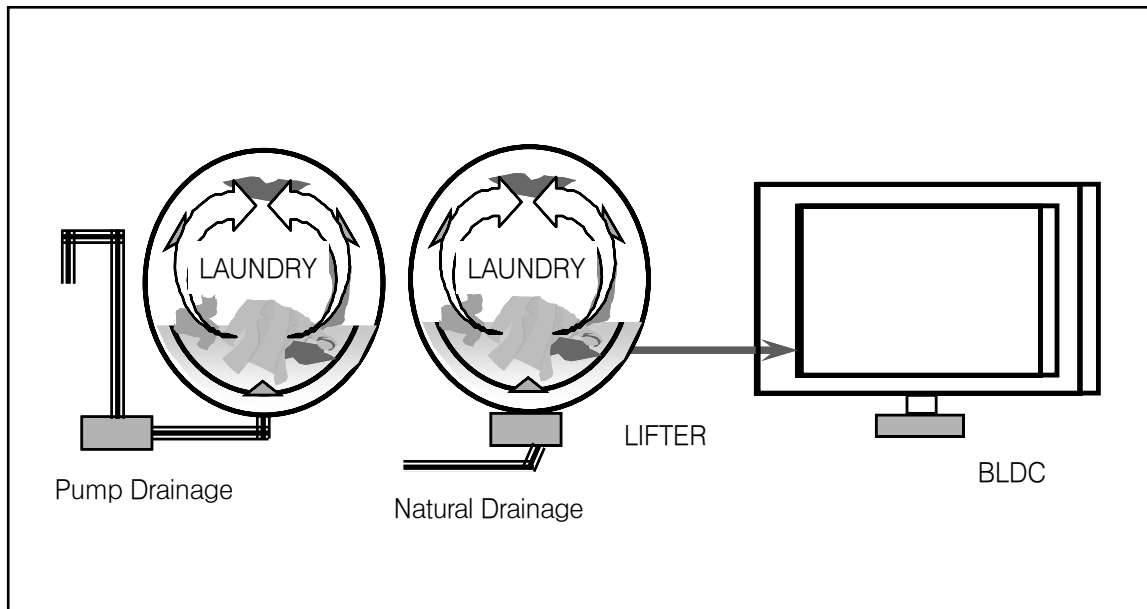

- DD Control: Direct drive type of direct connection between drum and motor
- Rotation by powerful high-performance BLDC motor
- Pump drainage type for built-in installation and Natural drainage

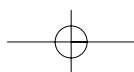

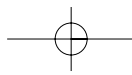

4. Major Functions

① Washing

When rotating drum after putting in the laundry and detergent into the drum, the laundry are rotated by protrusions (lifters) attached inside the drum.

Washing is carried out with bending and impact actions generated by falling of the laundry to the bottom part of drum.

② Rinsing

Rinsing cleanly washes out detergent and dirt removed from the laundry after washing cycle.

③ Spin-drying

Weak, standard and strong spin cycle can be selected according to types of fabrics to be washed. spin-wringing is carried out by rotation (the centrifugal force) of drum according to the designated speed.

④ Drainage

Pump Drainage: Powerful pump for built-in installation and application of filter to remove foreign substances

Natural Drainage: Applied Natural Drainage as the same pullsator.

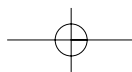

2.WASHER SPECIFICATION

1. Product Specification

① T125's series

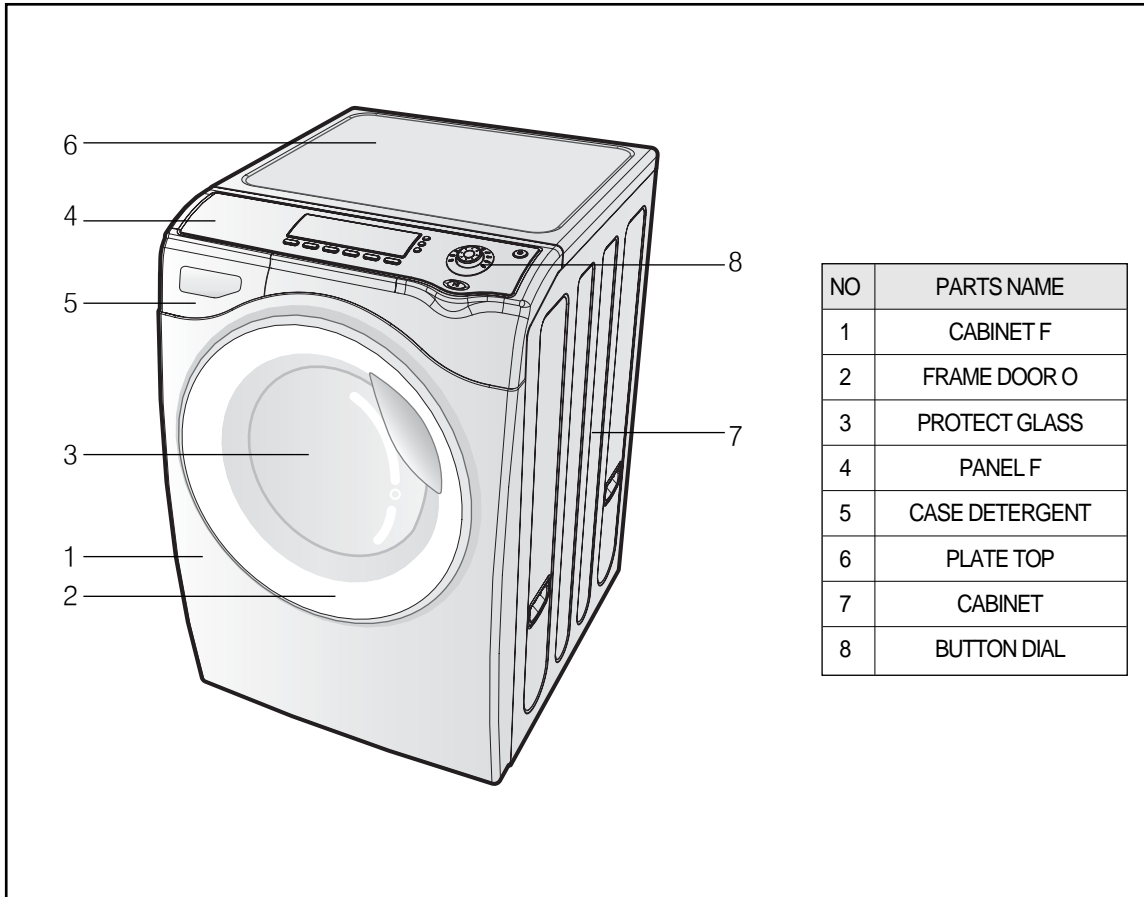

DIMENSION(WxDxH)		630mm(W) x 792mm(D) x 976mm(H)
MACHINE WEIGHT		82 kg
WATER CONSUMPTION		WASH 91 ℓ / DRY 51 ℓ
WASHING CONSUMPTION		31 ℓ
POWER SOURCE		230V/50Hz, 110V/60Hz, 127V/60Hz
POWER CONSUMPTION	WASHING	200W (Heating) ~ 2000W
	DRY	1200W ~ 2100W
CAPACITY	WASHING	12 kg
	SPIN	12 kg
	DRY	7 kg
WASHING TYPE		DRUM TYPE
DRY TYPE		Digital condensing dry system
OPERATION WATER PRESSURE		29kPa ~ 784kPa(0.3kgf/cm ² ~8kgf/cm ²)

② T123's series

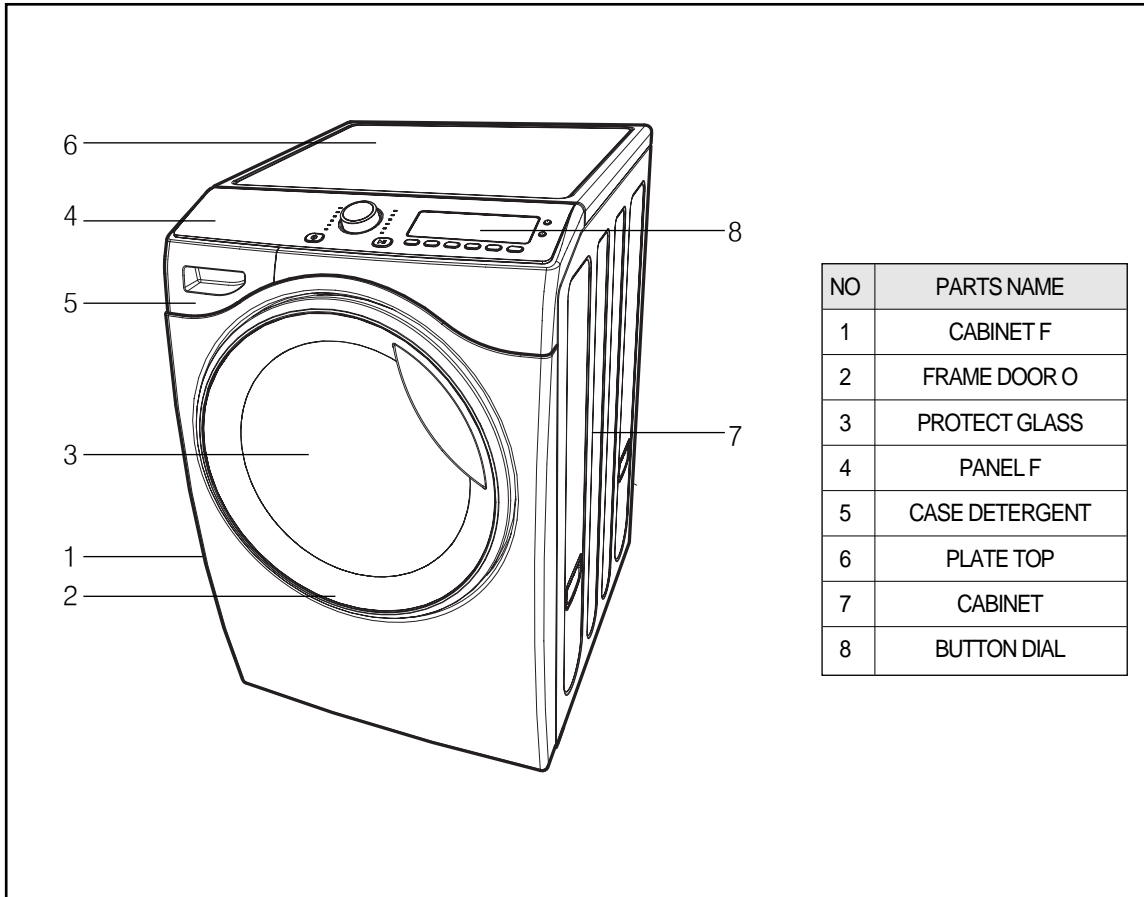

DIMENSION(WxDxH)		630mm(W) x 792mm(D) x 976mm(H)
MACHINE WEIGHT		82 kg
WATER CONSUMPTION		WASH 91 ℓ / DRY 51 ℓ
WASHING CONSUMPTION		31 ℓ
POWER SOURCE		230V/50Hz, 110V/60Hz, 127V/60Hz
POWER CONSUMPTION	WASHING	200W (Heating) ~ 2000W
	DRY	1200W ~ 2100W
CAPACITY	WASHING	12 kg
	SPIN	12 kg
	DRY	7 kg
WASHING TYPE		DRUM TYPE
DRY TYPE		Digital condensing dry system
OPERATION WATER PRESSURE		29kPa ~ 784kPa(0.3kgf/cm ² ~8kgf/cm ²)

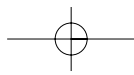

3. OPERATING MECHANISM DIAGRAM

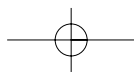
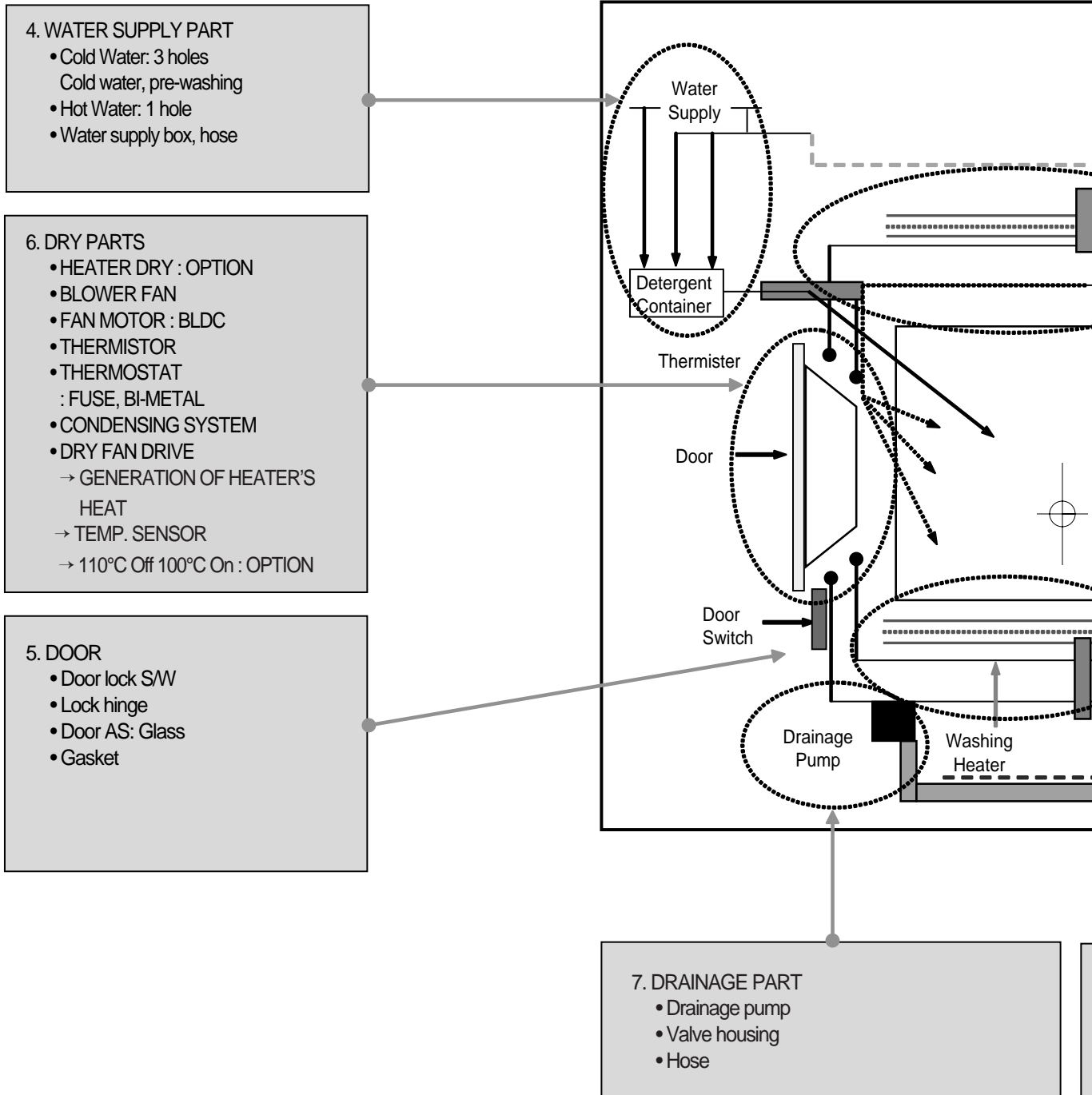

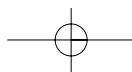
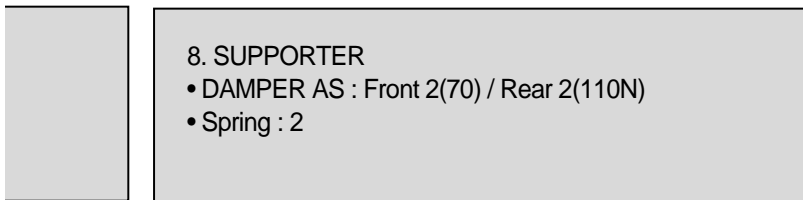
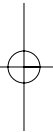
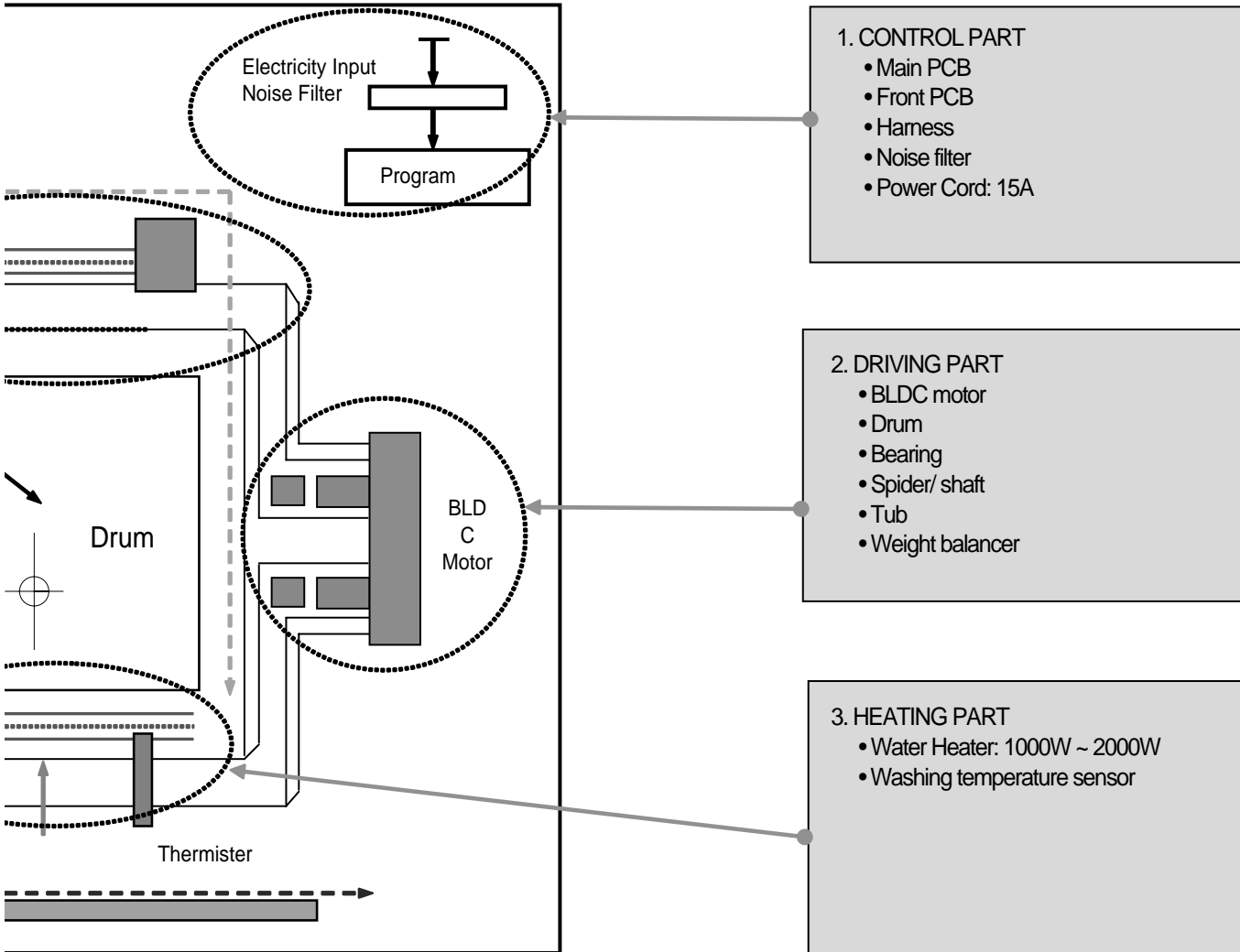
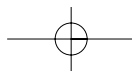

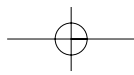

4. EACH PART OF DRUM WASHING MACHINE

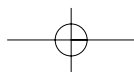
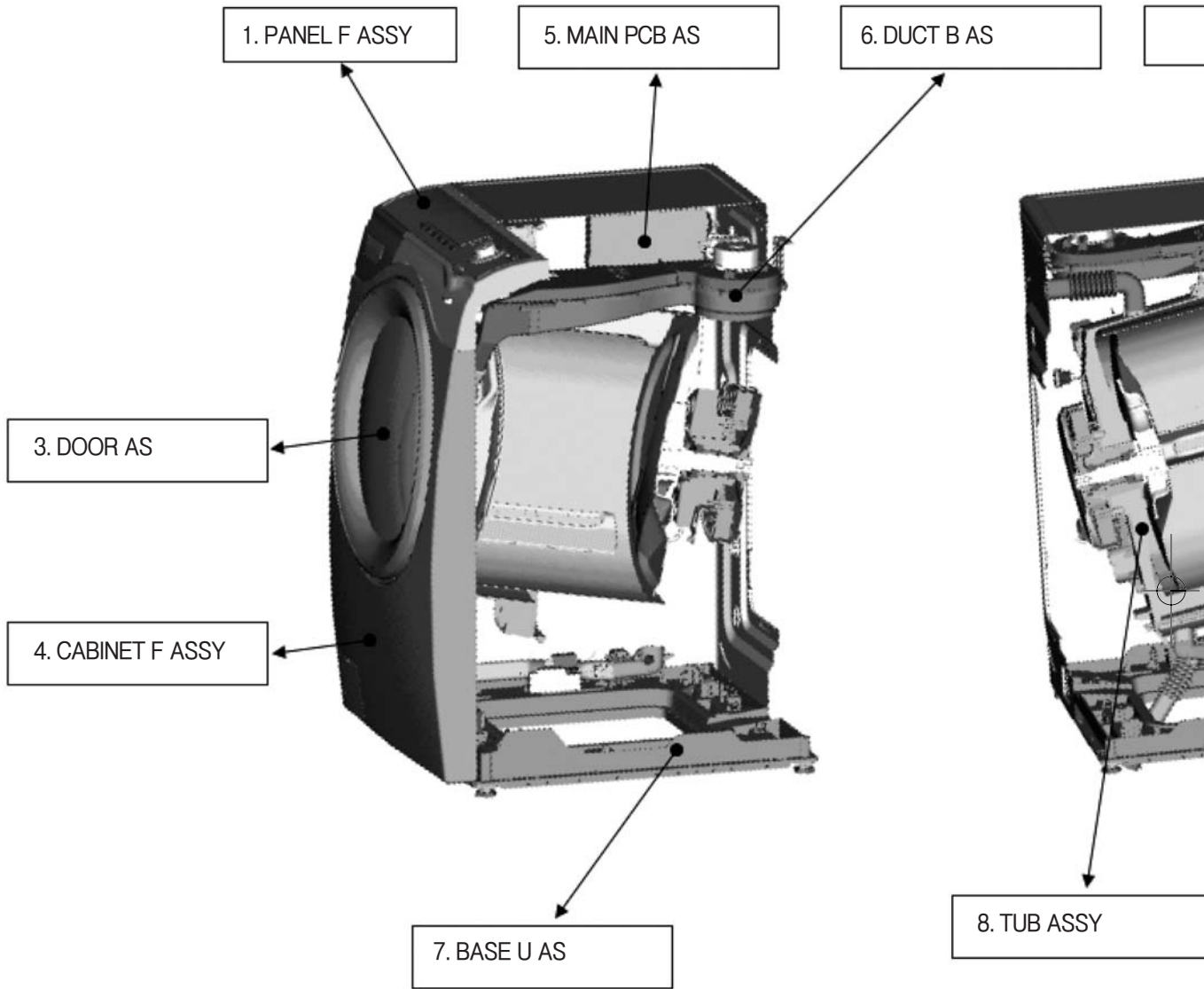

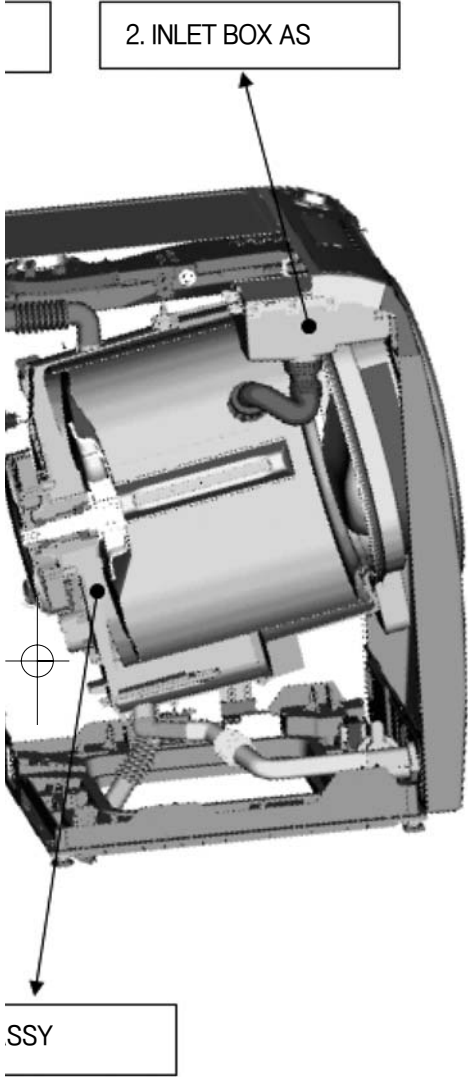
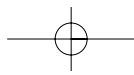

* TUB ASSY

- 1) BLDC ROTOR
- 2) BLDC STATOR
- 3) SHAFT
- 4) BEARING
- 5) SPIDER
- 6) DRUM
- 7) TUB

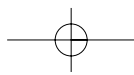
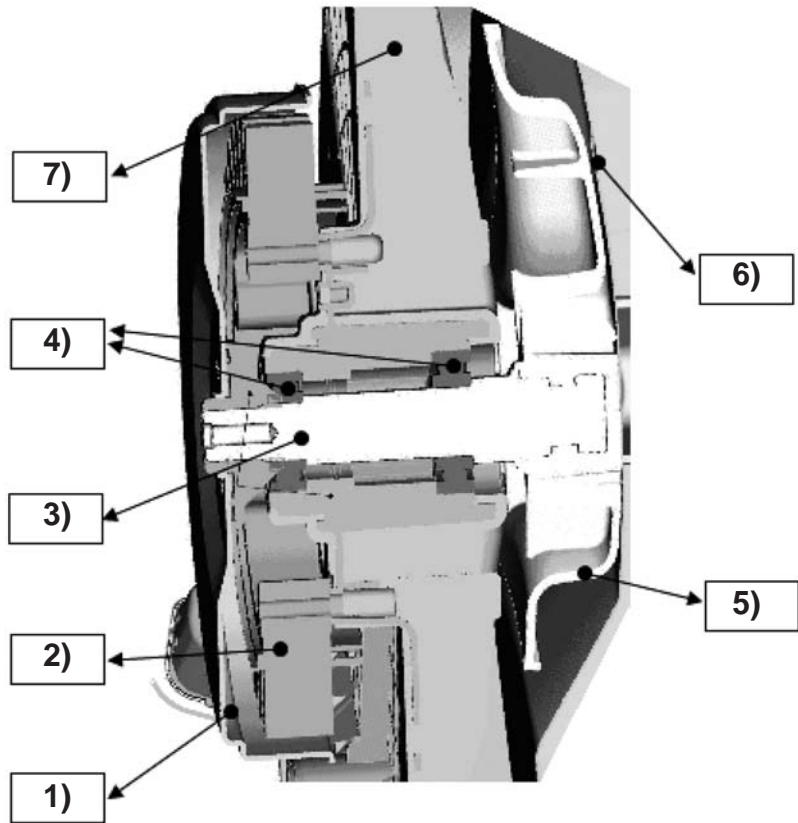

5. PARTS LIST BY ASS'Y

1. PANEL F AS

① T125's series

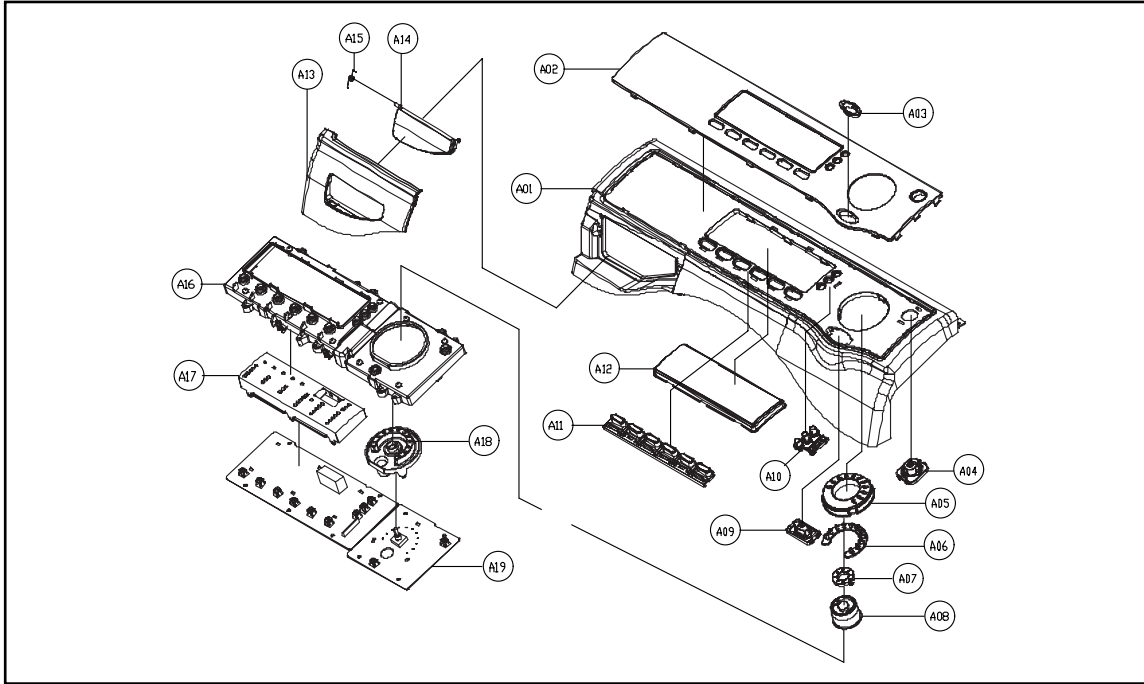

No.	PARTS NAME	CODE	SPECIFICATIONS	Q'TY	REMARK
A01	PANEL F OUTER	3614287900	ABS	1	
A02	PANEL F INNER	3614288000	ABS	1	
A03	DECORATOR START	3611686300	ABS	1	
A04	BUTTON POWER	3616637100	ABS	1	
A05	DECORATOR COURSE	3611686200	ABS	1	
A06	WINDOW COURSE	3615505700	Trans parency ABS	1	
A07	BUTTON DIAL IN	3616637300	ABS	1	
A08	BUTTON DIAL OUT	3616637500	Trans parency	1	
A09	BUTTON START	3616637600	ABS	1	
A10	BUTTON RES	3616637200	ABS	1	
A11	BUTTON FUNCTION	3616637700	ABS	1	
A12	WINDOW DISPLAY	3615505600	Trans parency ABS	1	
A13	CASE HANDLE	3611146800	ABS	1	
A14	HANDLE CAP	3612611300	ABS	1	
A15	SPRING CASE HANDLE	3615116000	SUS 304, D=0.6	1	
A16	CASE PCB F	3611146700	HIPS	1	
A17	HOLDER LED	3613054000	ABS	1	
A18	HOLDER LED COURSE	3613053900	ABS	1	
A19	PCB AS		DWD-T120R FRONT PCB ASSY	1	

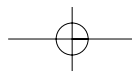

1. PANEL F AS

② T123's series

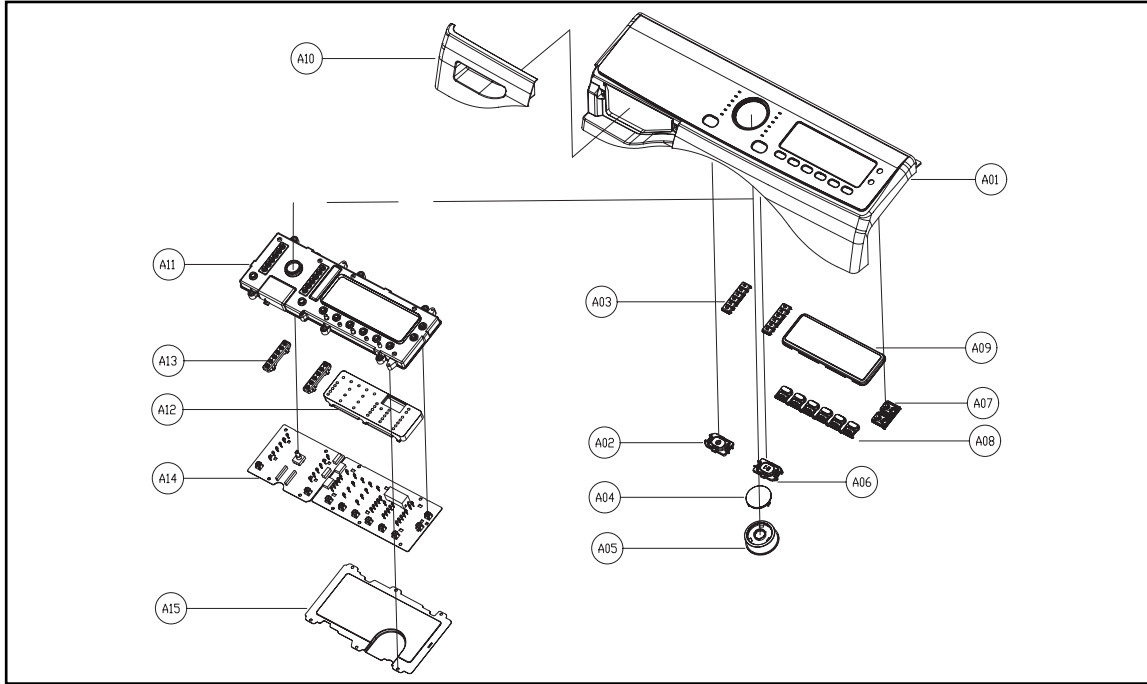

No.	PARTS NAME	CODE	SPECIFICATIONS	Q'TY	REMARK
A01	PANEL F	36142T1400	ABS	1	
A02	BUTTON POWER	3616638500	ABS	1	
A03	WINDOW COURSE	3615506600	ABS	2	
A04	KNOB DIAL IN	3613406400	ABS	1	
A05	KNOB DIAL OUTER	3613406500	ABS	1	
A06	BUTTON START	3616638600	ABS	1	
A07	BUTTON RES	3616638700	ABS	1	
A08	BUTTON FUNCTION	3616638400	ABS	1	
A09	WINDOW DISPLAY	3615506500	ABS	1	
A10	CASE HANDLE	36111T1400	ABS	1	
A11	CASE PCB F	36111T1300	HIPS	1	
A12	HOLDER LED FUNCTION	3613055000	ABS	1	
A13	HOLDER LED COURSE	3613054900	ABS	2	
A14	PCB AS		DWD-T123R FRONT PCB	1	
A15	PROTECTOR PCB	3618304800	SECC 0.6T, DWD-T110R	1	

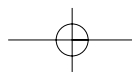

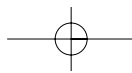

2. INLET BOX AS

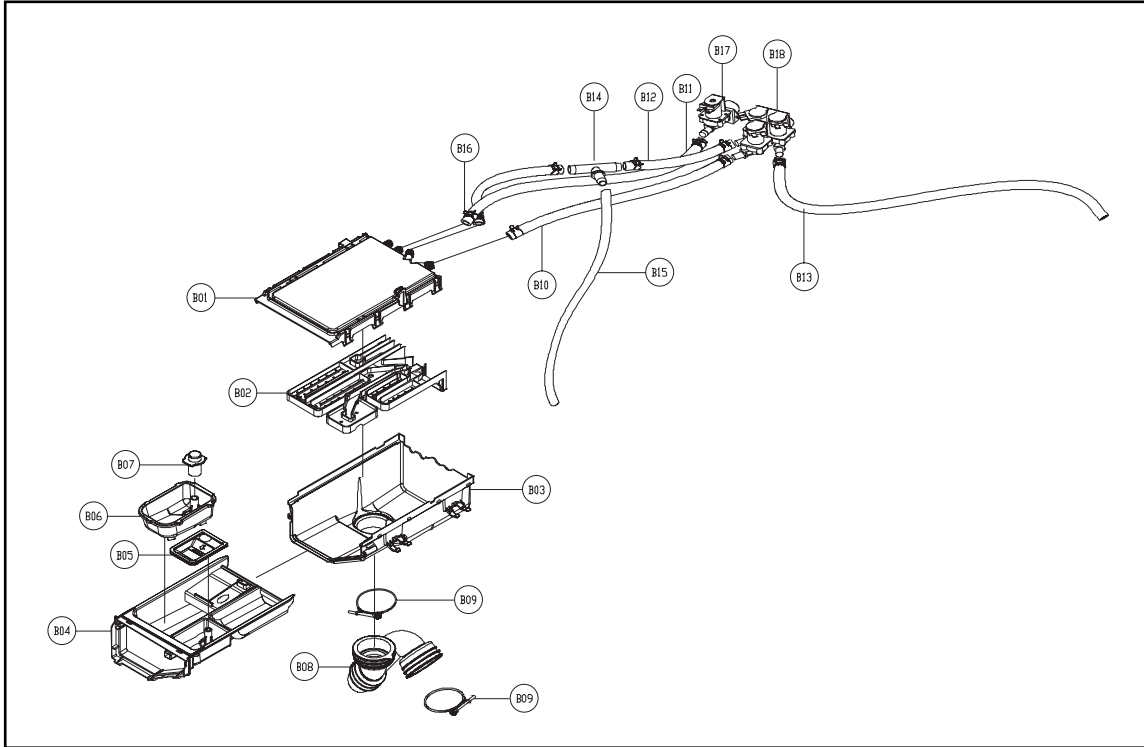

No.	PARTS NAME	CODE	SPECIFICATIONS	Q'TY	REMARK
B01	NOZZLE TOP	3618105400	PP	1	
B02	NOZZLE UNDER	3618105500	PP	1	
B03	INLET BOX	3617510900	PP	1	
B04	CASE DETERGENT	3611146400	PP	1	
B05	CAP SOFTENER	3610918300	PP	1	
B06	CASE LIQUID	3611147900	PP	1	
B07	CAP LIQUID	3610918000	PP	1	
B08	HOSE INLET	3613272000	EPDM, "U" TRAP	1	
B09	CLAMP AS	3611203200	ID=60, WIRE+GUIDE+BOLT+NUT	2	
B10	HOSE WATER SUPPLY	3613270900	EPDM ID9.5 OD14.5, L=320mm	1	Combo
			EPDM ID9.5 OD14.5, L=370mm	1	Wash
B11	HOSE WATER SUPPLY	3613270900	EPDM ID9.5 OD14.5, L=355mm	1	
B12	HOSE WATER SUPPLY	3613270900	EPDM ID9.5 OD14.5, L=170x2	2	
B13	HOSE WATER SUPPLY	3613270900	EPDM ID9.5 OD14.5, L=460mm	1	
B14	PIPE JOINT(HOSE INLET)	3614413300	PP	1	
B15	HOSE WATER SUPPLY	3613270930	EPDM ID8.5 OD12.5, L=530mm	1	
B16	CLAMP HOSE	3611205800	100H, ID=13.8 W=10.0 0.9T	8	
B17	VALVE INLET	3615415700	100~130V 1-WAY HOT PP-BRACKET	1	
		3615414800	HOT, 220~240	1	
B18	VALVE INLET	3615415070	100~130V, 3-WAY	1	
		3615415050	220~240V, 3WAY, RINSE GUIDE, PP/BRACKET	1	
		3615414900	220~240V, 2WAY, PP/BRACKET	1	

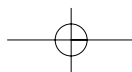

3. CABINET F ASSY

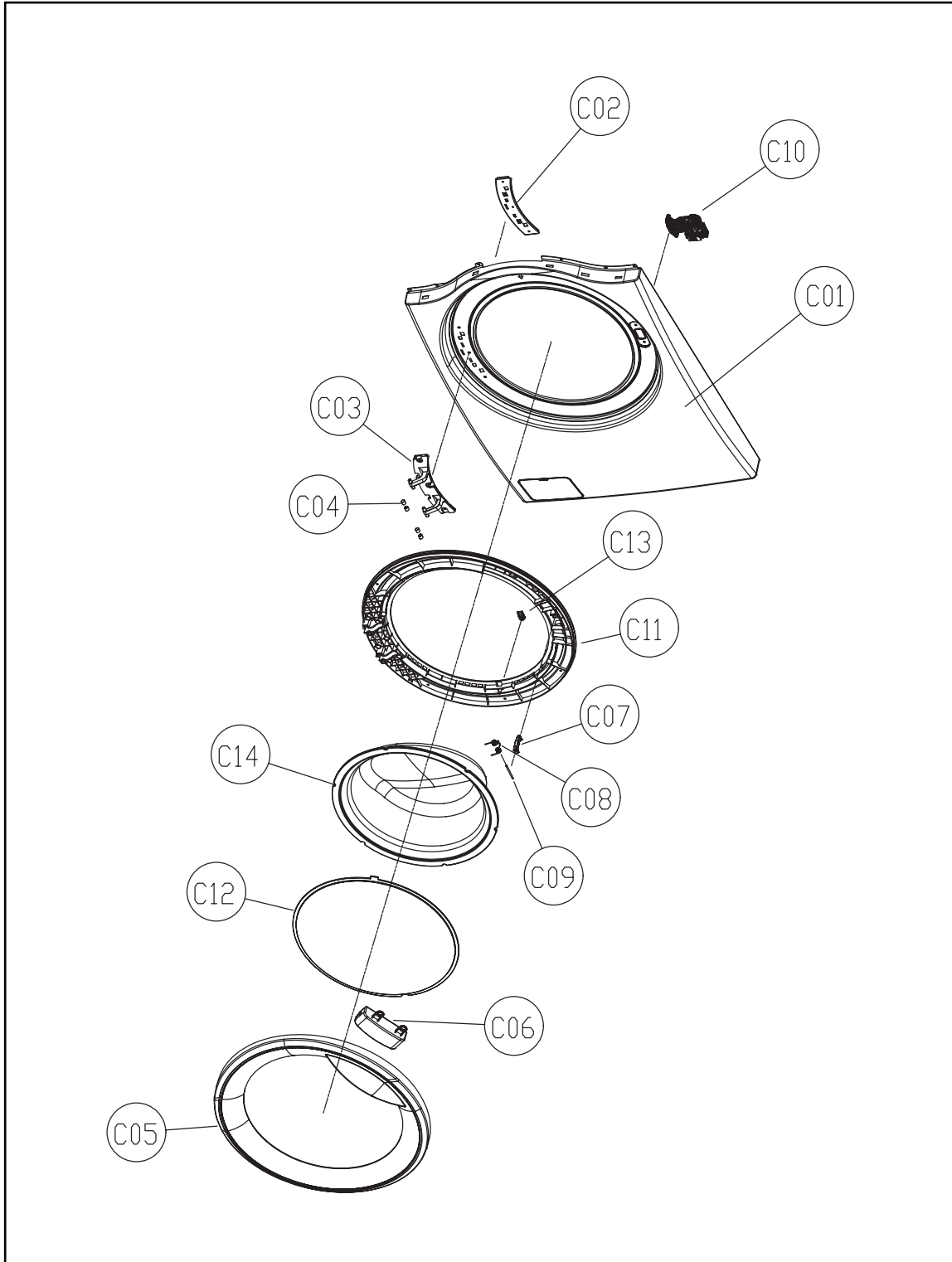

No.	PARTS NAME	CODE	SPECIFICATIONS	Q'TY	REMARK
C01	CABINET F	3610813000	SECD 0.8 t	1	
C02	PLATE HINGE SUPPORT	3614539800	SPG 0.8 t	1	
C03	HINGE DOOR	3612903800	AL	1	
C04	CAP HINGE DOOR	3610916500	POM	4	
C05	FRAME DOOR O	3612209900	ABS, CR	1	
C06	HANDLE COVER	3612611500	ABS	1	
C07	HOOK DOOR	3613100900	ZNDC	1	
C08	SPRING HOOK	3615115400	SUS304	1	
C09	HOOK SHAFT	3613101000	SUS, D=3.0	1	
C10	SWITCH DOOR LOCK	3619047210	DL-S1 125V 16A	1	
		3619047200	DL-S1 250V 16A BITRON		
C11	FRAME DOOR I	3612209800	PP	1	
C12	PROTECTOR GLASS	3618304300	PC	1	
C13	STOPPER DOOR	3615202400	ABS	1	
C14	DOOR GLASS	361A110600	GLASS	1	

4. CABINET ASSY

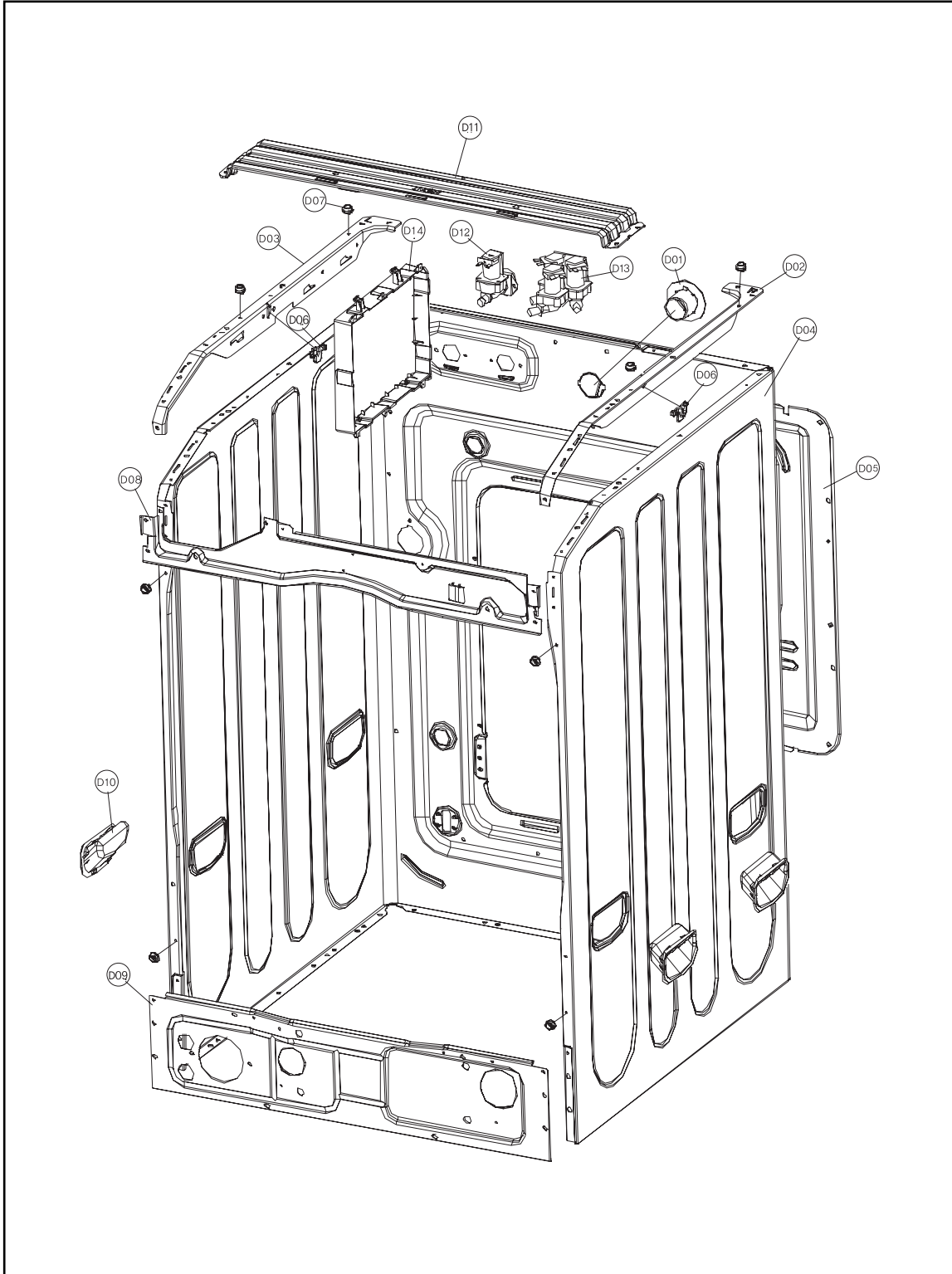

No.	PARTS NAME	CODE	SPECIFICATIONS	Q'TY	REMARK
D01	NOZZLE AIR	3618103110	PP, DWD-100DR	1	
D02	FRAME TOP R	3612209300	GI 1.6 t	1	
D03	FRAME TOP L	3612209400	GI 1.6 t	1	
D04	CABINET	3610812900	SGCC 0.8 t	1	
D05	COVER BACK AS	3611425540	COVER BACK + PAD CABINET	1	
D06	STOPPER SPRING	3615202200	POM, DWD-100DR	2	
D07	FIXTURE PLATE	3612008000	POM, 130RP	8	
D08	FRAME UPPER	3612209500	SBHG, 1.2 t	1	
D09	FRAME LOWER	3612204200	SBHG, 1.2 t	1	
D10	HANDLE CABINET	3612608100	PP, DWD-100DR	4	
D11	FRAME COVER	3612209600	SBHG, 1.2 t	1	
D12	VALVE INLET	3615415700	100~130V 1-WAY HOT PP-BRACKET	1	
		3615414800	HOT, 220~240		
D13	VALVE INLET	3615415070	100~130V, 3-WAY	1	
		3615415050	220~240V, 3WAY, RINSE GUIDE, PP/BRACKET		
		3615414900	220~240V, 2WAY, PP/BRACKET		
D14	CASE PCB MAIN	3611146200	HIPS, DWD-T110R	1	

5. BASE U AS

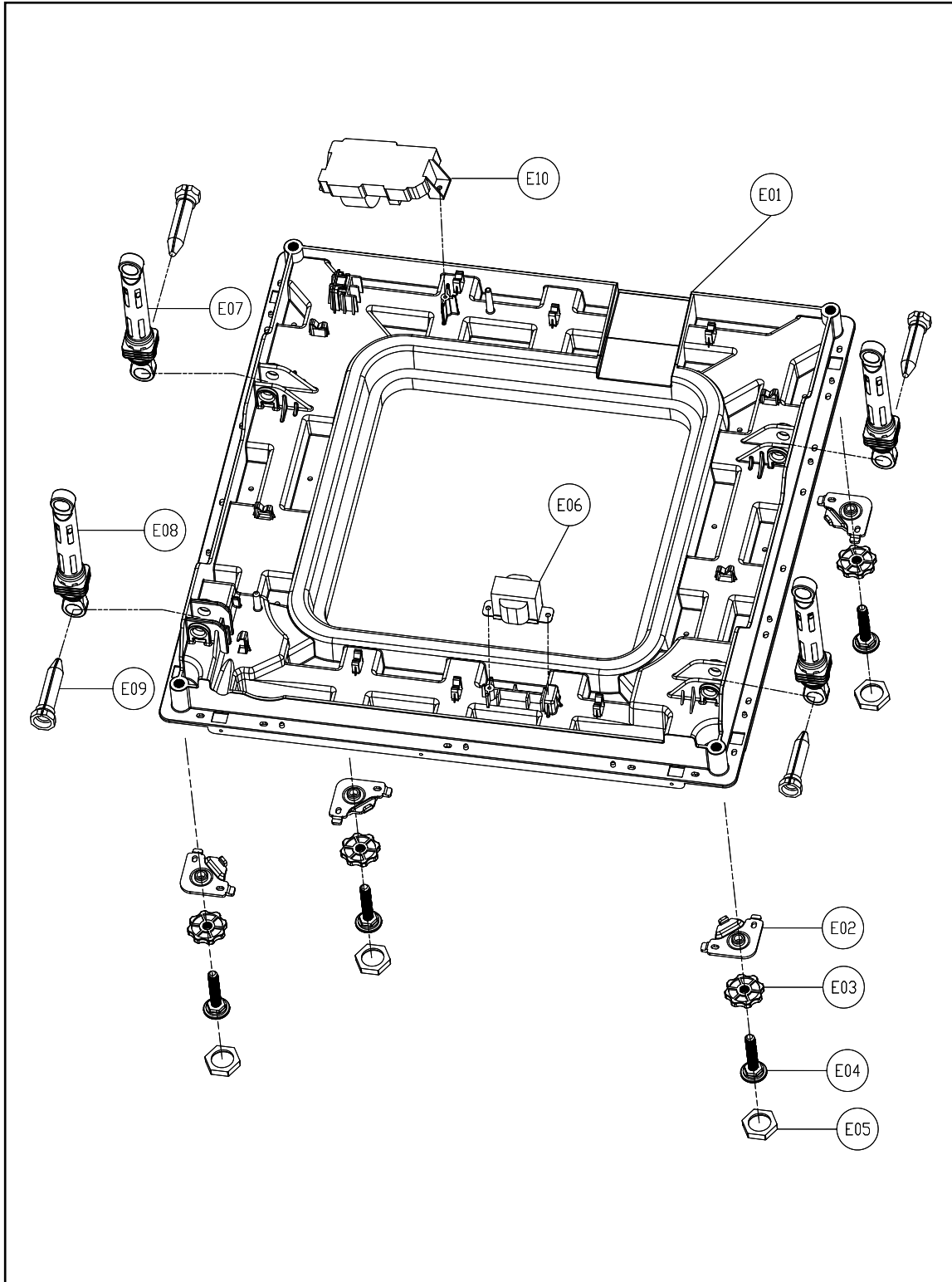

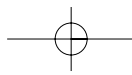

No.	PARTS NAME	CODE	SPECIFICATIONS	Q'TY	REMARK
E01	BASE U	3610393200	PP, DWD-T120R	1	
E02	SUPPORTER LEG	3615303600	PO+, 3.0T	4	
E03	FIXTURE LEG	3612006400	ABS, DWD-100DR	4	
E04	SPECIAL BOLT	3616029000	10 X 1.25, 51MM	4	
E05	FOOT	3612100600	BUTYL, DWD-100DR	4	
E06	REACTOR	52G043J002	DWD-100DR, 4A	1	
E07	DAMPER FRICTION	361A700150	110N AKS ST=170-260 DL=197.5 LOW NOISE	2	
E08	DAMPER FRICTION	361A700110	70N AKS ST=170-260 DL=197.5 LOW NOISE	2	
E09	DAMPER PIN	361A700200	AKS D=14.5	4	
E10	EMI FILTER(K19B)	3611909300	DWLF-K19(B110),X0.47U.Y1000P.VAR471K.NON FUSE	1	

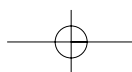

6. TUB ASSY

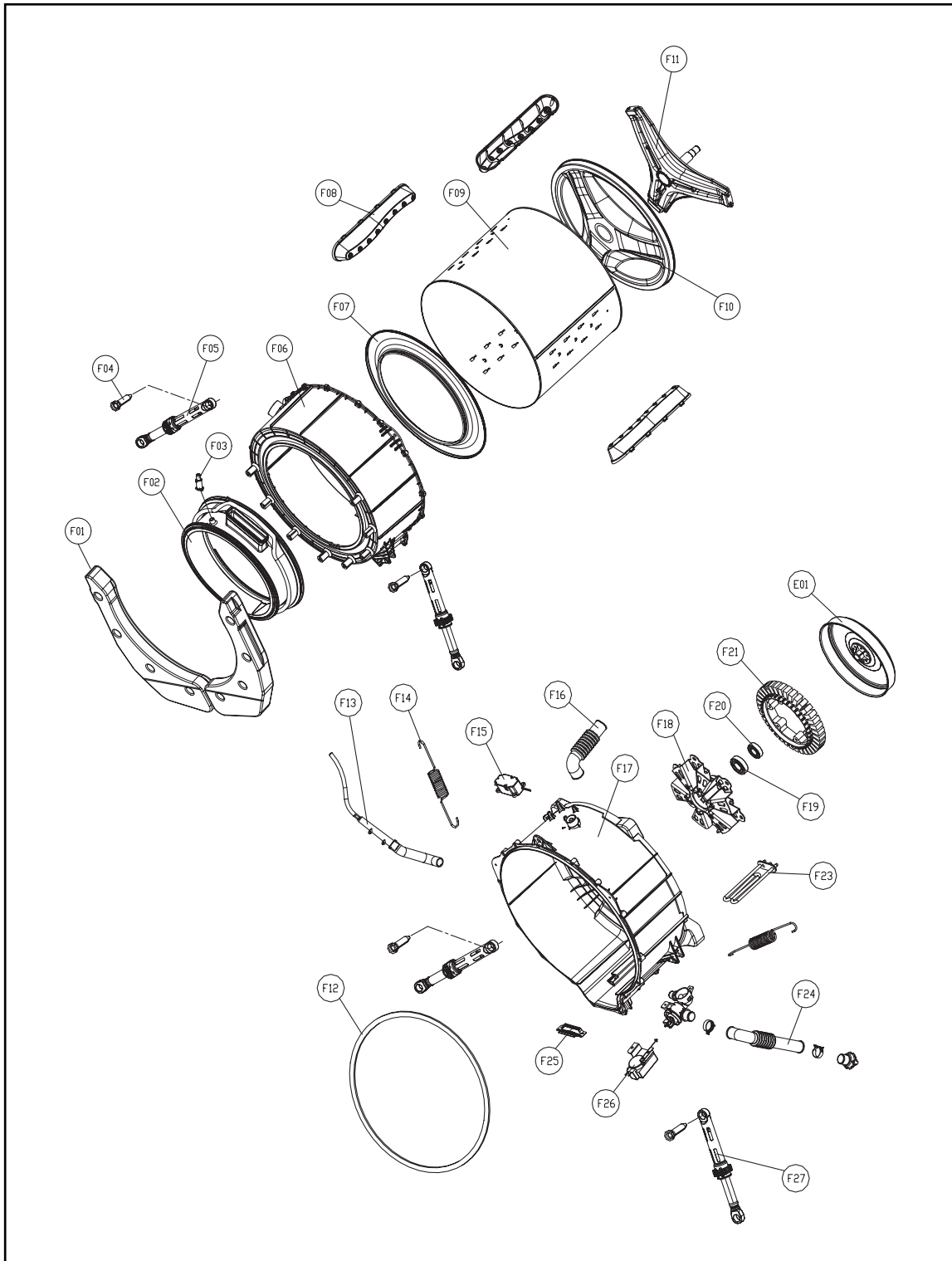

No.	PARTS NAME	CODE	SPECIFICATIONS	Q'TY	REMARK
F01	BALANCER WEIGHT	3616109000	DWD-T120R	1	
F02	GASKET DRY	3612323900	EPDM	1	
F03	NOZZLE SHOWER	3618104000	PP, DWD-100DR	1	
F04	DAMPER PIN	361A700200	AKS D=14.5	4	
F05	DAMPER FRICTION	361A700110	AKS, 70N	2	
F06	TUB FRONT	3618829800	FRPP, DWD-T120R	1	
F07	DRUM FRONT	3617003101	SUS, 0.5T	1	
F08	LIFTER WASH	361A400600	PP NANO-SILVER	3	
F09	DRUM CENTER	3617003010	SUS, 0.6T	1	
F10	DRUM REAR	3617003210	SUS, 0.6T	1	
F11	SPIDER AS	361A300200	SPIDER(ALDC)+SHAFT(S45C)	1	
F12	GASKET TUB	3612324300	L=1810	1	
F13	AIR TRAP AS	3610AAR120	DWD-T120R	1	
F14	SPRING SUSPENSION	3615115800	DWD-T120R	2	
F15	UNIT BUBBLE PUMP	3612802410	230V	1	
		36189L4G00	100V~130V	1	
F16	HOSE AIR	3613266300	EPDM	1	
F17	TUB REAR	3618829700	FRPP, DWD-T120R	1	
F18	BEARING HOUSING	3616304600	ALDC	1	
F19	BEARING INNER	3616303100	6206Z	1	
F20	BEARING OUTER	3616303200	6205Z	1	
F21	UNIT STATOR BLDC	36189L4800	36SLOT	1	
F22	UNIT ROTOR BLDC	36189L4900	MAGNET24	1	
F23	HEATER WASH	3512802400	220V 2000W	1	
		3612802410	230V 2000W	1	
		3612802440	100-130V 1000W	1	
		3612802430	110V 1000W	1	
F24	HOSE DRAIN I	3613266100	EPDM	1	
F25	FIXTURE HEATER	3612009300	SUS0.7T	1	
F26	DRAIN MOTOR	3619TAK00	110V	1	
F27	DAMPER FRICTION	361A700150	AKS	2	
F28	UNIT DRAIN PUMP AS	36189L5K30	220-240V / 50Hz	1	
		36189L5710	110-127V / 60 Hz	1	

7. DUCT B AS + DUCT PIPE AS

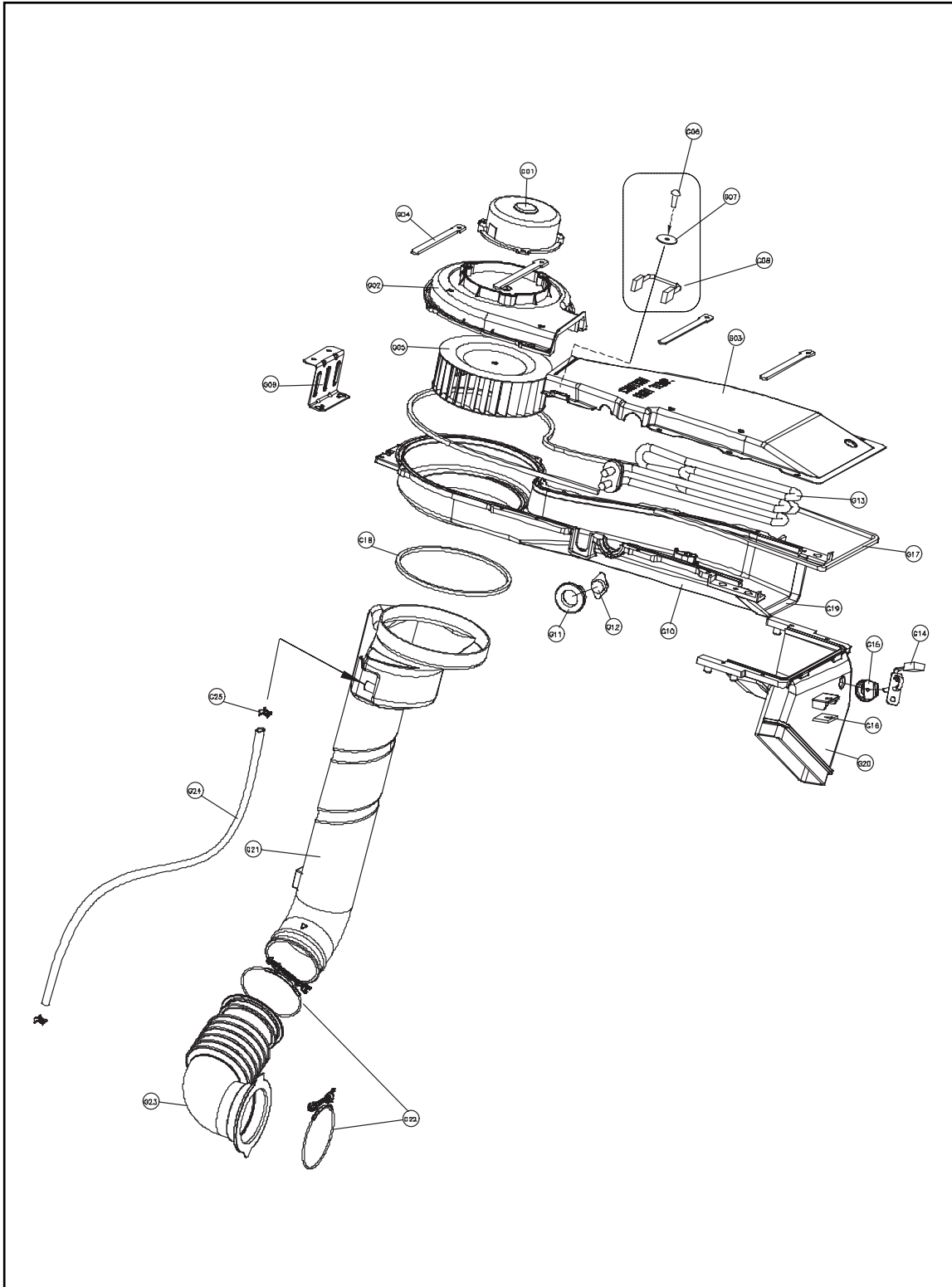

No.	PARTS NAME	CODE	SPECIFICATIONS	Q'TY	REMARK
G01	UNIT FAN MOTOR	36189L3Z20	ISM-7780 6DWWA 24V.	1	
G02	COVER DUCT	3611428700	ALDC	1	
G03	DUCT B UPPER	361A202100	ALCOST 0.5T	1	
G04	CLAMP CORD	3611203330	DABE-2, A=9, B=5,3, L=105	3	
G05	FAN AS	3611885900	DI33 FAN	1	
G06	SCREW TAPPING	7122400811	T2S TRS 4x8	1	
G07	SPECIAL SCREW AS	3616030100	TAPTITE P, TRS 4*16, WASHER	1	
G08	FUSE TEMPERATURE	361A800120	128°C(G4A0115C) 15A 250V	1	
G09	FRAME HEATER FRANGE	3612209700	SBHG 1.2t	1	
G10	DUCT B LOWER	361A202200	AL, 3t	1	
G11	PACKING THERMOSTAT	3614009900	SILICON	1	
G12	SWITCH THERMOSTAT	3619046500	ON 120°C OFF 150°C 230V	1	
G13	HEATER DRY	3612800900	220V 2100W	1	
		3612801400	230V 2100W	1	
		3612802100	120V 1200W	1	
		3612801300	110V 1200W	1	
G14	THERMISTOR DRY	361AAAAC30	R40=26.065Ω, R90=4.4278Ω	1	
G15	PACKING RUBBER	3614009800	SILICON	1	
G16	CUSHION DRY	3611570500	NBR, 20 x20 x 3T	2	
G17	GASKET SEAL A	3612324200	EPDM FOAM, DIA=5, L=1335	1	
G18	GASKET SEAL B	3612320810	EPDM FOAM, L=412, 4.9 x 4.4 x 4.8	1	
G19	GASKET INLET	3612323800	EVA, 10 x 211 x 1T	1	
G20	DUCT GUIDE	361A202300	AL, 3T	1	
G21	DUCT AS	361A200850	T120R	1	
G22	CLAMP AS(DUCT)	3611203700	DUCT	2	
G23	BELLOWS DUCT	3616403000	EPDM	1	
G24	HOSE WATER SUPPLY	3613270900	T120R	1	
G25	CLAMP SPRING	3611203800	ID=15.5, T=0.6, B=10	2	

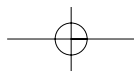

8. PLATE TOP ASSY

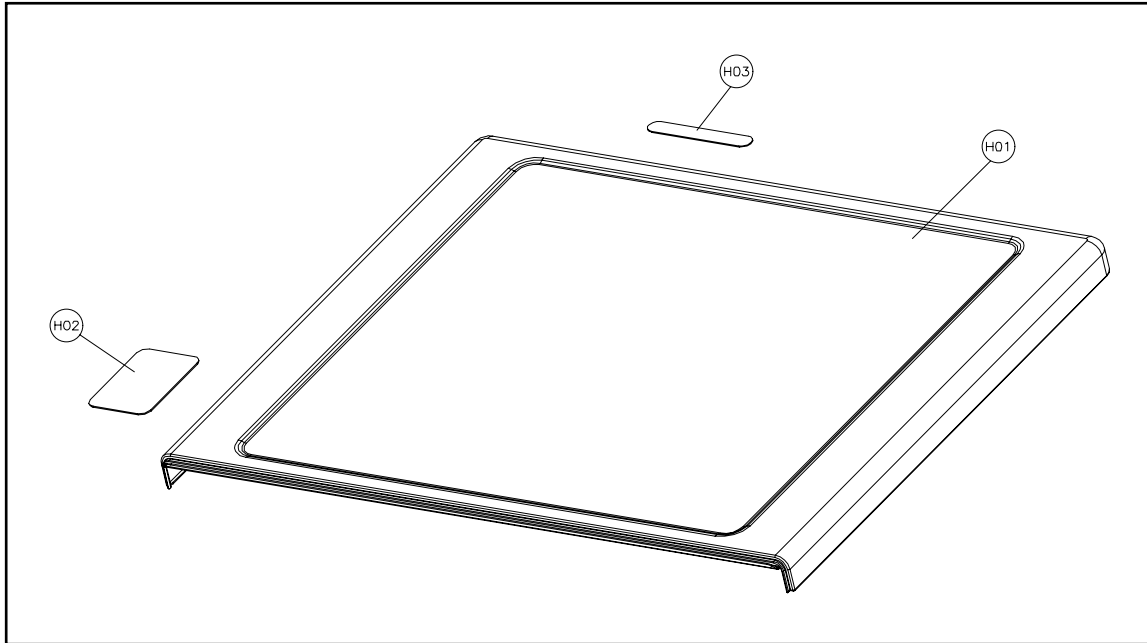

No.	PARTS NAME	CODE	SPECIFICATIONS	Q'TY	REMARK
H01	PLATE TOP	3614539900	SECC 1.2T	1	
H02	LABEL CAUTION	3613553830	PVC, SILK	1	
H03	LABEL INSTALL	3613555700	ART+OPP, WATER VALVE STICKER	1	

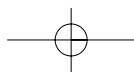

6. CONTROL PART FUNCTION SPECIFICATION

1. SEQUENCE CHART

Division	Time	Normal		Heavy Stain	Whites			
		Small	Middle	Middle	Small	Middle		
P R E W A S H	Sensing	20sec						
	Water Supply	2min			■			
	Pre. Wash	10min			■			
		8min			■			
	Drain	1min			■			
	Balancing Spin	2min			■			
Mid. Spin	3min			■				
W A S H I N G	Sensing	20sec	■	■		■	■	
	Water Supply	2min	■	■	■	■	■	
	Washing1 (Heating)	90min					75min	85min
		80min					■	■
		35min					■	■
		30min	27min	32min	■	■	■	■
		25min	■	■	■	■	■	■
	Washing2	40min	■	■	■	■	■	■
		25min	■	■	■	■	■	■
		20min	■	■	■	■	■	■
15min		■	■	■	■	■	■	
R I N S E	Drain	1min	■	■	■	■	■	
	Balancing Spin	2min	■	■	■	■	■	
	Mid. Spin	3min	■	■	■	■	■	
	Water Supply	2min	■	■	■	■	■	
	Rinse 1	3min	■	■	■	■	■	
	Drain	1min	■	■	■	■	■	
	Balancing Spin	2min	■	■	■	■	■	
	Mid. Spin	3min	■	■	■	■	■	
	Water Supply	2min	■	■	■	■	■	
	Rinse 2	3min	■	■	■	■	■	
	Drain	1min	■	■	■	■	■	
	Balancing Spin	2min	■	■	■	■	■	
	Mid. Spin	3min	■	■	■	■	■	
	Water Supply	2min	■	■	■	■	■	
Rinse 3	3min	■	■	■	■	■		
S P I N	Drain	1min	■	■	■	■	■	
	Balancing Spin	2min	■	■	■	■	■	
	Main Spin	7min	■	■	■	■	■	
		5min	■	■	■	■	■	
3min	■	■	■	■	■			
END	Crease care	60sec	■	■	■	■	■	
	End	10sec	■	■	■	■	■	
Remain Time Display			1:42	1:47	1:59	2:26	2:36	
NOTE		1. In the Heavy Stain Course, Prewash is included as Default. 2. Default Setting Times of Rinse in the Normal Course are two times. 3. If Choose the Normal Course and 40℃,Heating Time Included 7 min. about heater does not working. 4. According to Water Temperature, Wash Time is changed. 5. In the Normal Course, the laundry is perceived as full, washing time is added 1 hour						

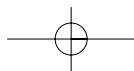

Division	Time	Delicate	Quick 30	Blanket	Sports Shoes	Tub Cleans	Air Wash	
		Small	Small	Middle	Small	High		
WASHING	Soak	30min				■		
	Water Supply	2min	■	■	■	■		
	Washing1 (Heating)	60min						
		50min						
		35min						
		30min						
	Washing2	20min				■		
25min				■	■			
20min		15min	8min	■	■	10min		
	15min	■	■	■	■	■		
RINSE	Drain	1min	■	■	■	■		
	Balancing Spin	2min	■	■	■	■		
	Mid. Spin	3min	■	■	■	■		
	Water Supply	2min	■	■	■	■		
	Rinse 1	3min	■	■	■	■		
	Drain	1min	■	Rinse 1 Water supply	■	■	■	
	Balancing Spin	1min	■		■	■		
	Mid. Spin	3min	■		■	■		
	Water Supply	2min	■		■	■		
	Rinse 2	3min	■		■	■		
	Drain	1min			■			
	Balancing Spin	2min			■			
	Mid. Spin	3min			■			
	Water Supply	2min			■			
Rinse 3	3min			■				
SPIN	Drain	1min	■	■	■	■		
	Balancing Spin	2min	■	■	■	■		
	Main Spin	7min	■	■	■	■	■	
		5min	■	■	■	■	■	
	3min	■	■	■	■	■		
DRY	Crease care	60sec			■	■		
	Dry	100min						
		30min				■	■	■
	Cooling	5min				■	■	■
	End	10sec				■	■	■
	Crease care	30min					■	
END	Crease care	60sec		■	■			
	End	10sec	■	■	■			
Remain Time Display			49	32	1:11	1:47	1:51	35
NOTE		1. In the Drum Drying Course, Dry is included as Default. 2. Crease care Course runs until pull out the laundry. 3. In the Shoes Course Crease care isn't included as Default 4. Spin of Shoes course isn't same default Spin Sequence						

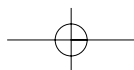

Division	Time	Eco-Steam	Normal Steam	Strong Steam	Baby Care	Steam Wash		Memory	
		Small	Small	Middle	Middle	Small	Middle		
S T E A M	Sensing	20sec	■	■	■	■	■	■	■
	Steam Water Supply	1min	■	■	■	■	■	■	■
	Steam Heating	20min			■	■	■	■	
		15min	■	■	■	■	■	■	■
	Stream Washing	25min			■	■	■	■	
		15min			■	■	■	■	
		10min			■	■	■	■	
	Finishing Water Supply	7min	■	■	■	■	■	■	■
1min		■	■	■	■	■	■	■	
Finishing Washing	25min	■	■	■	■	■	■	■	
W A S H I N G	Soak	30min							
	Water Supply	2min							
	Washing1 (Heating)	60min							
		50min							
		35min							
		30min							
	Washing2	15min							
25min		■	■	■	■	■	■	■	
20min		■	■	■	■	■	■	■	
	15min	■	■	■	■	■	■	■	
R I N S E	Drain	1min	■	■	■	■	■	■	
	Balancing Spin	2min	■	■	■	■	■	■	
	Mid. Spin	3min	■	■	■	■	■	■	
	Water Supply	2min							
	Rinse 1	3min	■	■	■	■	■	■	
	Drain	1min							
	Balancing Spin	2min							
	Mid. Spin	3min							
	Water Supply	2min							
	Rinse 2	3min	■	■	■	■	■	■	
	Drain	1min							
	Balancing Spin	2min							
	Mid. Spin	3min							
	Water Supply	2min							
	Rinse 3	3min							
	Drain	1min							
	Balancing Spin	2min							
Mid. Spin	3min								
Water Supply	2min								
Rinse 4	3min								
S P I N	Drain	1min	■	■	■	■	■	■	■
	Balancing Spin	2min	■	■	■	■	■	■	■
	Main Spin	7min	■	■	■	■	■	■	■
		5min	■	■	■	■	■	■	■
	3min	■	■	■	■	■	■	■	
END	Crease Care	60sec	■	■	■	■	■	■	■
	End	10sec	■	■	■	■	■	■	■
Remain Time Display			1:47	1:50	2:00	2:32	2:10	2:10	1:47
NOTE		1. Memory course is as same as add one rinse to eco-steam course. 2. Baby course and Steam White course work steam washing 25 minutes 3. 4 times rinse in the Baby Course							

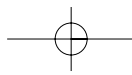

2. Skill of each Sequence

2-1. Washing Sequence

1) Washing Sequence part

Course \ part	LOAD SENSING	Water Level	Time	
			HEATING	Washing
Main	O	Decision Level	Decision Level	Decision Level
Pre	O	Decision Level	X	8 or 10 min
Soak	O	High	X	30min

- ① Prewash and Soak working previous main washing.
- ② Decision Level' decide Water Level and Time to Load Sensing in Normal,White,Eco-White Course.
- ③ Soak consist of water supply and washing, after this, start main washing.
- ④ Heater does not working in prewash and soak course.

2) Washing Time

Course \ part	Water Level	HEATING Time	Washing Time	Total Washing Time	
Normal	30℃	Small	20min	25min	45min
		Middle	25min	25min	50min
	40℃	Small	20min (+7)	40min	67min
		Middle	25min (+7)	40min	72min
	60℃	Small	30min	25min	55min
		Middle	45min	25min	70min
Whites	Small	75min	25min	100min	
	Middle	85min	25min	110min	
Steam Wash	30,40℃	Small	25min	25min	50min
		Middle	25min	25min	50min
	60℃	Small	30min	25min	55min
		Middle	30min	25min	55min
	90℃	Small	50min	25min	75min
		Middle	50min	25min	75min
Heavy Stain"	30,40℃	Middle	30min	25min	55min
	60℃	Middle	50min	25min	75min
Delicate	Small	X	15min	15min	
Quick 30	Small	X	8min	8min	
Blanket	Middle	X	25min	25min	
Sports shoes	Small	20min	20min	40min	
Baby Care	30,40℃	Middle	25min	25min	50min
	60℃	Middle	30min	25min	55min
	90℃	Middle	50min	25min	75min
Air Wash	X	X	X	X	
Tub Cleans	High	X	10min	10min	

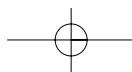

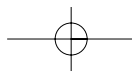

- ① Washing Heater isn't reworking after reach decision temperature.
- ② Normal Course + 40℃ include 7 min that heater does not working.
- ③ If Set up Normal + 40℃ then main washing time is 40 min.
- ④ If LS value is more than 360, 1 hour add in Washing Time.

3) Electric Current Time of Washing Motor

part Course	Water Temperature	MOTOR TIME On/OFF (sec)					Speed
		Water Supply	Washing		Soak	Crease Care	
			Heating	Main Washing			
Normal	0~40℃	5/10	10/10	18/6	15/180	10/5	45 r.p.m
	60℃	5/10	10/10	10/10	15/180	10/5	45 r.p.m
Whites	95℃	5/10	10/15	7/15	15/180	10/5	45 r.p.m
Steam Wash	30~40℃	5/10	10/10	10/10	15/180	10/5	45 r.p.m
	60℃	5/10	10/10	10/10	15/180	10/5	45 r.p.m
	95℃	5/10	10/15	7/15	15/180	10/5	45 r.p.m
Heavy Stain	0~40℃	5/10	18/7	10/5	15/180	10/5	45 r.p.m
	60℃	5/10	18/7	10/7	15/180	10/5	45 r.p.m
Delicate	Cold	X	X	2/15	X	X	45 r.p.m
Quick 30	Cold	5/10	X	18/6	X	10/5	45 r.p.m
Blanket	Cold	5/10	10/10	10/7	X	10/5	45 r.p.m
Sports shoes	0~40℃	5/10	10/10	10/7	15/180	10/5	45 r.p.m
Baby Care	30~40℃	5/10	10/10	10/10	15/180	10/5	45 r.p.m
	60℃	5/10	10/10	10/10	15/180	10/5	45 r.p.m
	95℃	5/10	10/15	7/15	15/180	10/5	45 r.p.m
Tub Cleans	Cold	5/10	X	10/30	X	10/5	45 r.p.m

- ① It works decision cycle
- ② If Motor Restriction occur by overload, Motor try to rework opposite direction.
- ③ While Water Supply, Motor Stir proceed ON first.
- ④ Crease Care is process of removal laundry that stick to drum. It works after Spin Sequence.
- ⑤ Electric Current Time of Washing Motor ON/OFF Time is finishing washing of Steam White and Baby Course.
- ⑥ Each Time of Electric Current Time of Washing Motor of Steam White and Baby Course is 10/5, 18/6.

4) Re-Water Supply

- ① It works if water level is lower than decision level
- ② Motor stopped while Re-Water Supply
- ③ While Wash Sequence Re-Water Supply works 15 times.
- ④ If Water Level is lower than RESET Level, Display IE and Heater off.

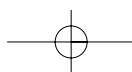

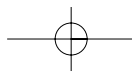

2-2. Rinse Sequence

1) Water Supply Sequence

Water Level \ part	level height (mm)	KHz	etc
High	240	22.96	Add Rinse water level
Mid	225	23.18	Rinse water level

- ① Only cold water supply in Rinse Sequence
- ② In last Rinse Sequence, use fabric conditioner by open water valves.

2) Re-Water Supply

- ① After 1 min in Rinse Sequence, check water level and work Re-Water Supply.

3) Rinse Sequence

Water Level \ part	Water Temp	Rinse Time	Mid. Spin	Mid. Spin r.p.m	MOTOR On/OFF (sec)		
					rpm	water supply	rinse
Normal	Cold	3min	3min	mid	45 r.p.m	5/10	10/5
Whites	Cold	3min	3min	weak	45 r.p.m	5/10	10/5
Steam Wash	Cold	3min	3min	weak	45 r.p.m	5/10	10/5
Heavy Stain	Cold	3min	3min	mid	45 r.p.m	5/10	10/5
Baby Care	Cold	3min	3min	weak	45 r.p.m	5/10	10/5
Sports shoes	Cold	3min	3min	weak	45 r.p.m	X	10/5
Delicate	Cold	3min	3min	weak	45 r.p.m	X	2/20
Quick 30	Cold	3min	3min	mid	45 r.p.m	5/10	10/5
Blanket	Cold	3min	3min	weak	45 r.p.m	5/10	10/5
Tub Cleans	Cold	3min	3min	weak	45 r.p.m	5/10	10/5

4) Drain

- ① Before Drainage Sequence, Water Temp. is dropped by cold water supply.
- ② After Drainage Sequence, Drain Motor is still ON

5) Mid. Spin

- ① Mid Spin is performed to decision r.p.m. If it can't R-Spin while performed 20 times, pass to next sequence.
- ② In Shoes Course, does not working B-Spin.

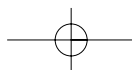

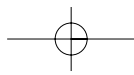

2-3. Spin Sequence

- 1) Drain
 - ① It follows Drainage Sequence.
- 2) Balance Spin
 - ① If Unbalance Check pass, Start R-Spin.
 - ② B-Spin is Until Unbalance check section, 350 r.p.m
- 3) R(Real) Spin
 - ① From end of B-Spin to end of Spin Sequence is R Spin.
 - ② r.p.m is affected by sequence
- 4) Shoes Spin
 - ① Balace Spin does not working.

2-4. End

- 1) Crease Care
 - ① Crease Care is process of removal laundry that stick to drum. It works 30sec ,after Spin Sequence.
 - ② Wool and Shoes course don't work crease care
- 2) End
 - ① After 10 sec power off ,alamed END.
 - ② If drying sequence added, work drying sequence.
 - ③ After END , door unlock.

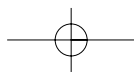

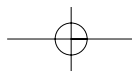

2-5. Drying Sequence

1) consist of drying sequence.

ex) select normal drying (Total spend time 2:30)

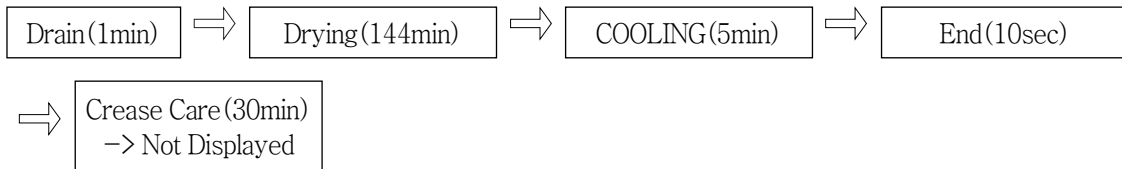

2) Drying Spin

Course	Drying Spin	Etc
Normal	MAX	All course performance Max spin.
Whites	MAX	
Steam Wash	MAX	
Heavy Stain	MAX	
Quick 30	MAX	

① All course performance Max spin.

3) Crease Care

① Crease Care proceed 60 sec.

4) Electric Current Time of Dry Sequence.

	Crease Care	Drying	COOLING	Wrinkle Free	Time	Heater Off/On Temperature(°C)
Low	10/5	15/5	10/10	10/50	110	70/60
Low(Shoes)	10/5	2/30	2/30	X	36	70/60
Iron	10/5	15/5	10/10	10/50	60	105/95
Normal	10/5	15/5	10/10	10/50	150	105/95
Strong	10/5	15/5	10/10	10/50	200	105/95

5) Drying V/V working

① It work from the after 20sec, In Drying Sequence to End of Drying Sequence.

6) COOLING

① Fan motor and Main motor work at once during Cooling Sequence.

② Temp. of Drum is less than 50°C finish Cooling Sequence.

③ Cooling time is total 5 min.

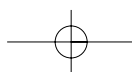

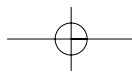

7) Drying Heater working

- ① Drying Heater work until End of Drying Sequence.
- ② Shoes Course : 70°C OFF / 60°C ON
- ③ Air Course : 80°C OFF / 70°C ON

8) Crease Care

- ① Crease Care performance after Drying Sequence for 30 min.
- ② Only Motor work during Wrinkle Free

2-6. Steam Sequence

1) Steam water supply

- ① Water Supply time is 1 min., 2 times, in Steam Sequence.

2) Steam Heating

- ① In order to increase water temp. , heater work.
- ② Steam Heating Temperature.

Course	Temperature	Time
Eco	70°C	15min
Normal	75°C	15min
Strong	90°C	20min

3) Steam Washing

- ① This sequence is enable to maximum effect of steam and maintain water temperature.
- ② Steam Washing Time

Course	Time	Heater On/Off temperature
Eco	7min	70°C/75°C
Normal	10min	75°C/80°C
Strong	15min	90°C/95°C
Strong	25min	90°C/95°C

4) Finishing Steam Water Supply

- ① Same the normal water supply.
- ② Water Supply spend 1 min.

5) Finishing Steam Wash

- ① It works if can't reach decision temp. of Main Washing
- ② spend 25 minutes.

6) Main Washing

- ① Same the normal washing

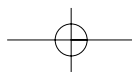

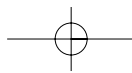

3. Main Function of PCB Program

3-1. LOAD SENSING

1) Deciding the water level

- ① Normal, White, Eco-White Course will be followed by this process.
- ② Check the water level with dry laundry at the starting wash.
- ③ Check the water level by using motor output data during 20 sec, 65rpm.

2) Deciding Spin Starting Step.

- ① Check after finishing washing step with wet laundry.
- ② Checking by using motor output data during 20 sec, 65 rpm.
- ③ The Decided data is different depending on loading condition.

3-2. Balance Spin

1) Motor running during balance spin

- ① Spreading the laundry : Rotating the same 45 rpm with left and right direction alternatively.
- ② Unbalance checking point : first step, check the U.B at 95 rpm, 160 rpm second step, check the U.B at 95 rpm 350 rpm.
Third step at 300 rpm. If the unbalance data is over the criterion
This process will be repeated.
- ③ After drain, check the unbalance data again. This is so-called balance spin step.

3) Property of balance spin

- ① Conducting 20 times maximum.
- ② If the washer can not pass balance spin step during 20 times, then water will be supplied.
- ③ If the washer can not pass 20 times of balance spin, UE error mode will be displayed on '18:88'

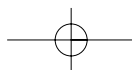

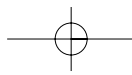

3-3. DOOR S/W

1) The working principle of Door S/W

- ① Door Locking
Bimetal on (3 sec) --> solenoid (supply 20msec pulse 2 times)
- ② Door Unlocking
Bimetal off --> solenoid(supply 20msec pulse, until lock)
- ③ After door locking all parts can work normally.
- ④ After pressing power button, if the temperature of wash thermistor is over 55°C or the water level is over the safety level, the door will be locked.
- ⑤ The door will be unlocked immediately after all processes are finished.
- ⑥ The door can be opened during processing if there is no problem to unlock.

2) DOOR OPEN SYSTEM

- ① If add the laundry during washing, press the door unlock button.
- ② Door open sequence at abnormal condition.

3-4. Child Lock

- ① Press the "Spin" and "Condensing Dry" button simultaneously during processing.
- ② Under the Child Lock function, only power button is working.
- ③ During Child Lock function, CHL will be displayed on '18:88'
- ④ In order to unlock Child Lock mode, press "Spin" and "Condensing Dry" simultaneously.

3-5. The sequence of drain

- ① If the checking time to reset point is below 1 min, the remaining drain time is 30 sec.
- ② If the checking time to reset point is over 1 min, the remaining drain time is 2 min.
- ③ If the checking time to reset point is over 10 min, OE signal will be appeared on PCB.
- ④ If the temperature is over 50°C , the water will be supplied to high water level, then the drain will start.

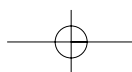

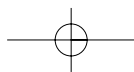
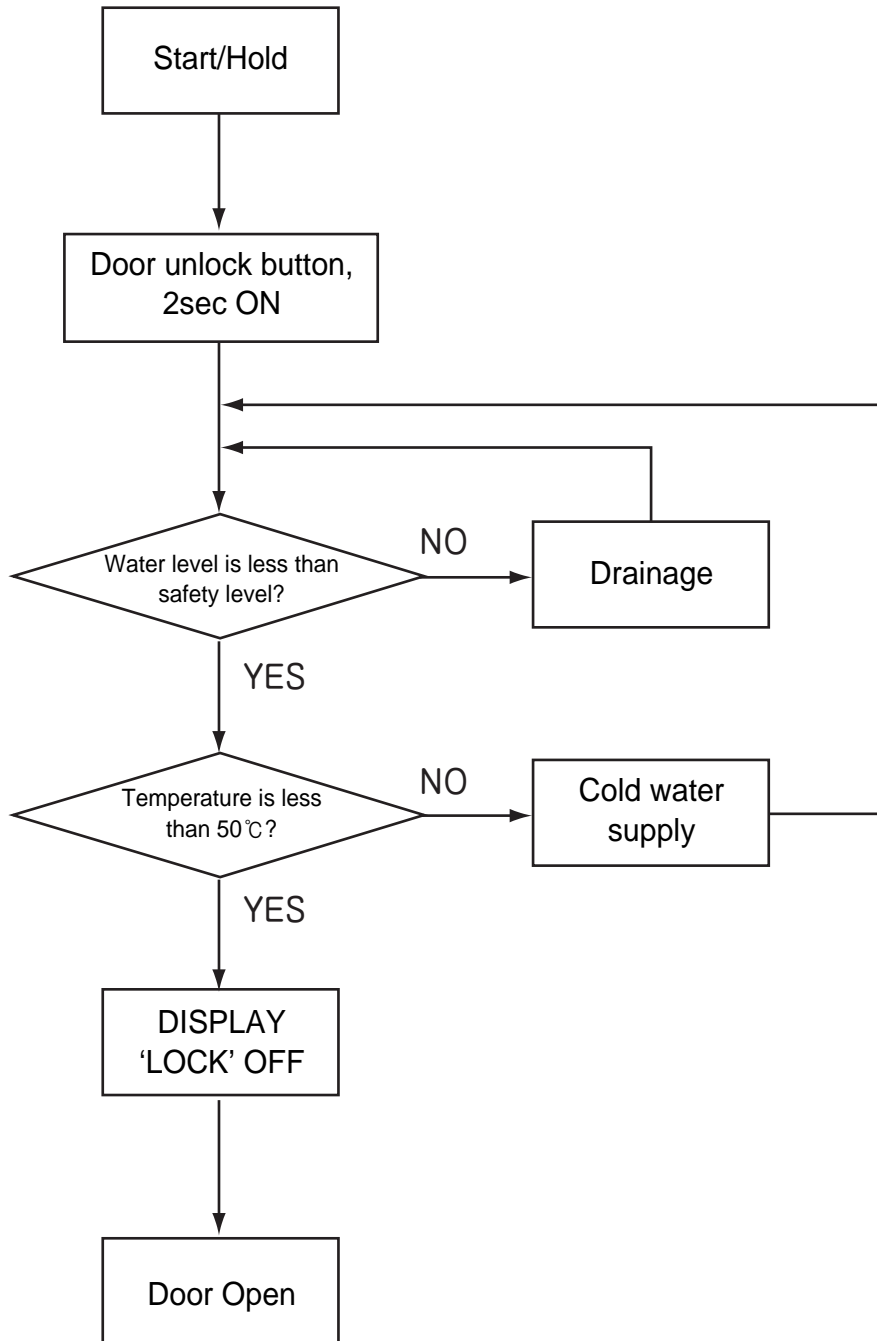
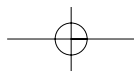

5. TEST MODE

5-1. Testing Mode

PCB and other electronic parts will be tested without water supply whether they are normal or not.

1) Process

press power button --> press "SPIN" button 3 times with pressing "WASH" button --> 'L d' will be shown on LED -->

Whenever pressing "TEMP" button 1 time, below process will be occurred.

MICOM Ver. --> L C (Lock Closed) --> run (count) --> b1, b2, b3, b4, b5, b6, b7

--> F (Fan Motor) --> H (Hot V/V)

--> C (Cold V/V) --> P (prewashing V/V) --> d (dry V/V) --> bb (bubble)

--> dr (drain motor) --> L O (Lock S/W Open)

2) More details

1 When turn on 'LOCK' signal, all process is conducting normally.

2 When working starts, the PCB displays all the sensor conditions.

3 In this case, BLDC Motor is not tested. In order to test it, select spin or rinse.

5-2. Continuous testing mode

1) Process

after pressing "WASH", "RINSE", "SPIN" button simultaneously, press "POWER" button.

ALL LED On --> SPIN button --> ALL LED off

--> L C (Lock Close) --> r (Motor right) --> L (Motor Left)

--> F (Fan Motor) --> H (Hot V/V) --> C (Cold V/V) --> b (Pre whsh V/V) --> d (dry V/V)

--> bb (bubble) --> h1 (Wash heater) --> h2 (Dry heater) --> dr (Drain motor On)

--> L O (Lock S/W Open)

2) More tails

1 LED test can be done with all LED On.

2 All sensor conditions will be shown on PCB during processing.

6-1. Error Display

6-1. IE (Input Error) - Error in water supply

1) Conditions of Occurrence

- ① In case the designated water level is not reached in 5 minutes during water supply or re-supply

2) All LEDs are turned off and 'IE' blinks in 18:88 display.

3) Error buzzer alarm is sounded for 10 seconds per every 10 minutes.

4) Error display is cleared when turning off/ on power.

6-2. OE (Output Error) - Error in drainage

1) Conditions of Occurrence

- ① In case water level does not reach reset point in 10 minutes after drainage starts

2) All LEDs are turned off and 'OE' blinks in 18:88 display.

3) Error buzzer alarm is sounded for 10 seconds per every 10 minutes.

4) Error display is cleared when turning off/ on power.

6-3. UE (Unbalance Error)

1) Conditions of Occurrence

- ① In case main spin-drying is not reached within 20 cycles of balance spin-drying
- ② In case balance spin-drying fails during interim spin-drying, UE occurs as the cycle moves to the next process.

2) All LEDs are turned off and 'UE' blinks in 18:88 display.

3) Error buzzer alarm is sounded for 10 seconds per every 10 minutes.

4) Error mode is cleared by opening door and organizing the laundry in spin-dry chamber, closing door and pressing start/ temporary stop button. Then, spin-drying begins again.

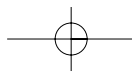

6-4. LE (Lock Error) - Door opening error

1) Conditions of Occurrence

- ① When intending to begin cycle by pressing start/ temporary stop button while door is opened

2) All LEDs are turned off and 'LE' blinks in 18:88 display.

3) Error buzzer alarm is sounded for 10 seconds per every 10 minutes.

4) Error display is cleared when turning off/ on power.

6-5. E1 - Water level detection error

1) Conditions of Occurrence

- ① In case water level is below reset or overflow is detected in line test mode

2) Water supply motor is kept on until water level falls below reset.

3) All LEDs are turned off and 'E1' blinks in 18:88 display.

4) Error buzzer alarm is sounded for 10 seconds per every 10 minutes.

5) Error display is cleared when turning off/ on power.

6-6. E2 - Overflow error

1) Conditions of Occurrence

- ① In case water level in water tank is above overflow level due to continuous operation of water supply valve

2) Water supply motor is kept on until water level falls below reset.

3) All LEDs are turned off and 'E2' blinks in 18:88 display.

4) Error buzzer alarm is sounded for 10 seconds per every 10 minutes.

5) Error display is cleared when turning off/ on power.

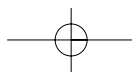

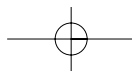

6-7. E4 - Water leakage during washing

1) Conditions of Occurrence

- ① In case water level falls below re-supply even after 15 times of re-supply prior to finishing of water heating

2) All LEDs are turned off and 'E4' blinks in 18:88 display.

3) Error buzzer alarm is sounded for 10 seconds per every 10 minutes.

4) Error display is cleared when turning off/ on power.

6-8. E9 - Abnormalities in water level sensor

1) Conditions of Occurrence

- ① In case water level frequency is of 15KHz or lower and 30KHz or higher during cycle due to abnormalities in water level sensor, etc.

2) All LEDs are turned off and 'E9' blinks in 18:88 display.

3) Error buzzer alarm is sounded for 10 seconds per every 10 minutes.

4) Error display is cleared when turning off/ on power.

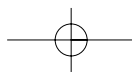

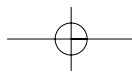

6-9. Motor-related Error

1) E5 (DC-Link High Voltage) Error

- ① In case DC-link voltage to IPM increases to 450V or higher
- ② Motor operation is stopped and 'E5' is shown in display window.
- ③ Error buzzer alarm is sounded for 10 seconds per every 10 minutes.
- ④ Error display is cleared when turning off/ on power.

2) E6 (EMG) Error

- ① In case current detected with EMG port is of 20A or higher
- ② Motor operation is stopped and 'E6' is shown in display window.
- ③ Error buzzer alarm is sounded for 10 seconds per every 10 minutes.
- ④ Error display is cleared when turning off/ on power.

3) E7 (Direction) Error

- ① In case signal of Hall IC is different from the predicted signal according to direction of rotation
- ② Motor operation is stopped and 'E7' is shown in display window.
- ③ Error buzzer alarm is sounded for 10 seconds per every 10 minutes.
- ④ Error display is cleared when turning off/ on power.

4) E8 (Initial Operation Fail) Error

- ① In case input signal of Hall IC is abnormal due to problems in motor connection, etc.
- ② Motor operation is stopped and 'E8' is shown in display window.
- ③ Error buzzer alarm is sounded for 10 seconds per every 10 minutes.
- ④ Error display is cleared when turning off/ on power.

6-10. Error in Temperature Sensor

1) H2 Error - Washing temperature sensor open/ short

- ① In case washing temperature sensor is defective or not connected
- ② Error buzzer alarm is sounded for 10 seconds per every 10 minutes.
- ③ Error display is cleared when turning off/ on power.

2) H4 Error - Washing temperature sensor overheating

- ① In case temperature detected by washing temperature sensor is 95℃ or higher
- ② Error buzzer alarm is sounded for 10 seconds per every 10 minutes.
- ③ Error display is cleared when turning off/ on power.

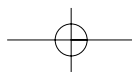

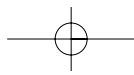

3) H5 Error - Water temperature error in wool/ delicate course

- ① In case water temperature in wool/ delicate course is 45°C or higher
- ② Error buzzer alarm is sounded for 10 seconds per every 10 minutes.
- ③ Error display is cleared when turning off/ on power.

4) H6 Error - Abnormality in washing heater

- ① Within 15 minutes after heater operation begins;
In case standard temperature is of 42°C or lower: If temperature does not increase by 2°C or more In
case standard temperature is higher than 42°C: If temperature does not increase by 1°C or more
- ② If temperature falls below standard temperature by 2°C or more due to re-supply of water, etc.,
standard temperature is reset as the current temperature and error check time of 15 minutes is reset.
- ③ Error buzzer alarm is sounded for 10 seconds per every 10 minutes.
- ④ Error display is cleared when turning off/ on power.

5) H8 Error - Washing heater overheating

- ① In case washing heater temperature increases by 5°C or more within 30 seconds when there is no
water in tank, etc.
- ② Error buzzer alarm is sounded for 10 seconds per every 10 minutes.
- ③ Error display is cleared when turning off/ on power.

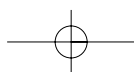

7. ELECTRONIC FIELD PARTS LIST AND SPECIFICATION

NO	PART NAME	Rating(V/Hz)	PART CODE	BOM DESCRIPTION
1	VALVE INLET	100-130V	3615415070	100~130V,3WAY,RINSE GUIDE유,PP/BACKETVAL
	VE INLET	100-130V	3615415700	100-130 1-WAY HOT PP-BRACKET
	VALVE INLET	220-240V	3615414800	220-240V 1-WAY HOT PP-BRACKET
	VALVE INLET	220-240V	3615415050	220~240V,3WAY,RINSE GUIDE유,PP/BRACKET
	VALVE INLET	220-240V	3615415060	220~240V,3WAY,RINSE GUIDE유,NYLON/BACKET,VDE
2	SENSOR PRESSURE	5V	3614825200	5V DRUM, DN-DD01, DL-DW01, INLET 90
3	CORD POWER AS	220-240V	3611339340	H05VV-F 1.5SQ 250V16A FERRITE
	CORD POWER AS	220-240V	3611339930	H05VV-F 1.5SQ 250V16A EU-2P FERRITE
	CORD POWER AS	100-130V	3611340410	UL.SJT 16AWG 125V 13A, #1806 3P CONN
	CORD POWER AS	100-130V	3611339810	BSMI 2.0SQ 2C 125V 15A TAIWAN
4	UNIT BUBBLE PUMP	220-240V	3612802410	220-240V
	UNIT BUBBLE PUMP	100-130V	36189L4G00	
5	HARNESS AS		3612797800	Combo Non Pump , Full option
	HARNESS AS		3612797810	Combo Non Pump , Cold Only
	HARNESS AS		3612797820	Combo Non Pump , Cold Only , Non Bubble
	HARNESS AS		3612797830	Wash Non Pump , Full option
	HARNESS AS		3612797840	Wash Non Pump , Non Bubble
	HARNESS AS		3612797850	Wash Non Pump , Cold Only
	HARNESS AS		3612797860	Wash Non Pump , Cold Only , Non Bubble
	HARNESS AS		3612797870	Combo Pump, Full option
	HARNESS AS		3612797900	Combo Pump, Non Bubble
	HARNESS AS		3612797910	Combo Pump, Cold Only
	HARNESS AS		3612797920	Combo Pump, Cold Only , Non Bubble
	HARNESS AS		3612797930	Wash Pump , Full option
	HARNESS AS		3612797940	Wash Pump , Non Bubble
	HARNESS AS		3612797950	Wash Pump , Cold Only
	HARNESS AS		3612797960	Wash Pump , Cold Only, Non Bubble
6	HARNESS EARTH	All	3612793410	GN/YW AWG18 FERRITE Ø29
7	FUSE TEMPERATURE	15A 250V	361A800120	128℃ DF-128S 15A 250V VDE
8	SWITCH DOOR LOCK	100-130V	3619047200	DL-S1.250V16A.BITRON
	SWITCH DOOR LOCK	220-240V	3619047210	DL-S1.125V16A.BITRON
9	HEATER WASH	220-240V	3612802400	220V 2KW.1R0A721001.RW8TF.IRCA
	HEATER WASH	220-240V	3612802410	230V 2KW.1R0A721002.RW8TF.IRCA
	HEATER WASH	100-130V	3612802440	120V 1KW.1R0A721005.RW8TF1PE.IRCA
	HEATER WASH	100-130V	3612802430	110V 1KW.1R0A721004.RW8TF.IRCA
10	HEATER DRY	220-240V	3612800900	220V 2100W 23.05OHM 6.1W/SQ INCOLOY800 1R1A034001
	HEATER DRY	220-240V	3612801400	230V 2.1KW 25.19OHM 6.1W/SQ INCOLOY800 1R1A034002
	HEATER DRY	100-130V	3612802100	UL120V/1.2KW12OHM3.5W/SQ.INCOLOY800.RA8.1R1A034006
	HEATER DRY	100-130V	3612801300	110V 1.2KW 10.08OHM 3.5W/SQ INCOLOY800 1R1A034005

NO	PART NAME	Rating(V/Hz)	PART CODE	BOM DESCRIPTION
11	SWITCH THERMOSTAT	100-250V	3619046500	ON120°C OFF150°C 230V 15A VDE
12	UNIT STATOR BLDC	28T	36189L4800	Φ265X28H,36SLOT,2SNESOR,3254D02000
	UNIT STATOR BLDC	28T	36189L4830	Φ265X28H,36SLOT,2SNESOR,3254D02000, 28T AL COIL
	UNIT ROTOR BLDC	28T	36189L4900	MAGNET24,SERRATION,WR1238F001
13	THERMISTOR WASH	All	361AAAAB10	R25=1.704kΩ R80=11.981kΩ
14	THERMISTOR DRY	Dry	361AAAAC30	R40=26.065kΩ,R90=4.4278kΩ
15	UNIT FAN MOTOR	Dry	36189L3Z00	ISM-77806DWWA 24V,CW,8P,14W
16	FAN AS	Dry	3611886100	D133*46L,PPGF30%,HANYU
17	DRAIN MOTOR	220-240V	36196TAJ00	SV-MX7T20D 220-50/60 ST23(56.5)
	DRAIN MOTOR	100-130V	36196TAK00	SV-HJ7T20D 100-110V ST23(56.5)
18	DAMPER FRICTION	12kg All	361A700110	70N AKS ST=170-260 DL=197.5 LOW NOISE
	DAMPER FRICTION	12kg All	361A700150	110N AKS ST=170-260 DL=197.5 LOW NOISE
	DAMPER PIN	12kg All	361A700200	AKS D=14.5
19	EMI FILTER(K19B)	12kg All	3611909300	DWLF-K19,X0.47U.Y1000P.VAR471K.NON-FUSE
20	UNIT DRAIN PUMP AS	220-240V	36189L5K30	AL.220-240/50 B20-6 30W 11KG
	UNIT DRAIN PUMP AS	100-130V	36189L5710	40W 110-127V/60HZ DRUM(11KG-FILTER) CU

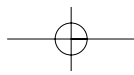

	Classification		SPEC
	Combo	Wash	
	◎		NT-103NA(5XV)F150-120, ±5°C
	◎	◎	Vm 310VDC, Vcc5V, 2SENSOR
28T AL COIL			STATOR:CLASS B, 36SLOT T28, AIR GAP 1mm, ROTOR :φ265x28H, Magnet24
			OUTPUT WASH 145W, TORQUE 300Kgf.cm(at45RPM),
	◎	◎	
	◎		CHIP KCD263H399F, B25/85=3992K ±2%, L/W UL1007 AWG24 L=450, MG621164(KET)
	◎		3φ BLDC, MAGNET8, Vm24V(7~28V) Vcc5V,
	◎		
	◎		
	◎	◎	DAMPER(70N)
	◎	◎	DAMPER(110N)
	◎	◎	-
FUSE	◎	◎	-
CU			

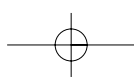
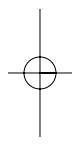
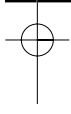

1. PCB PIN

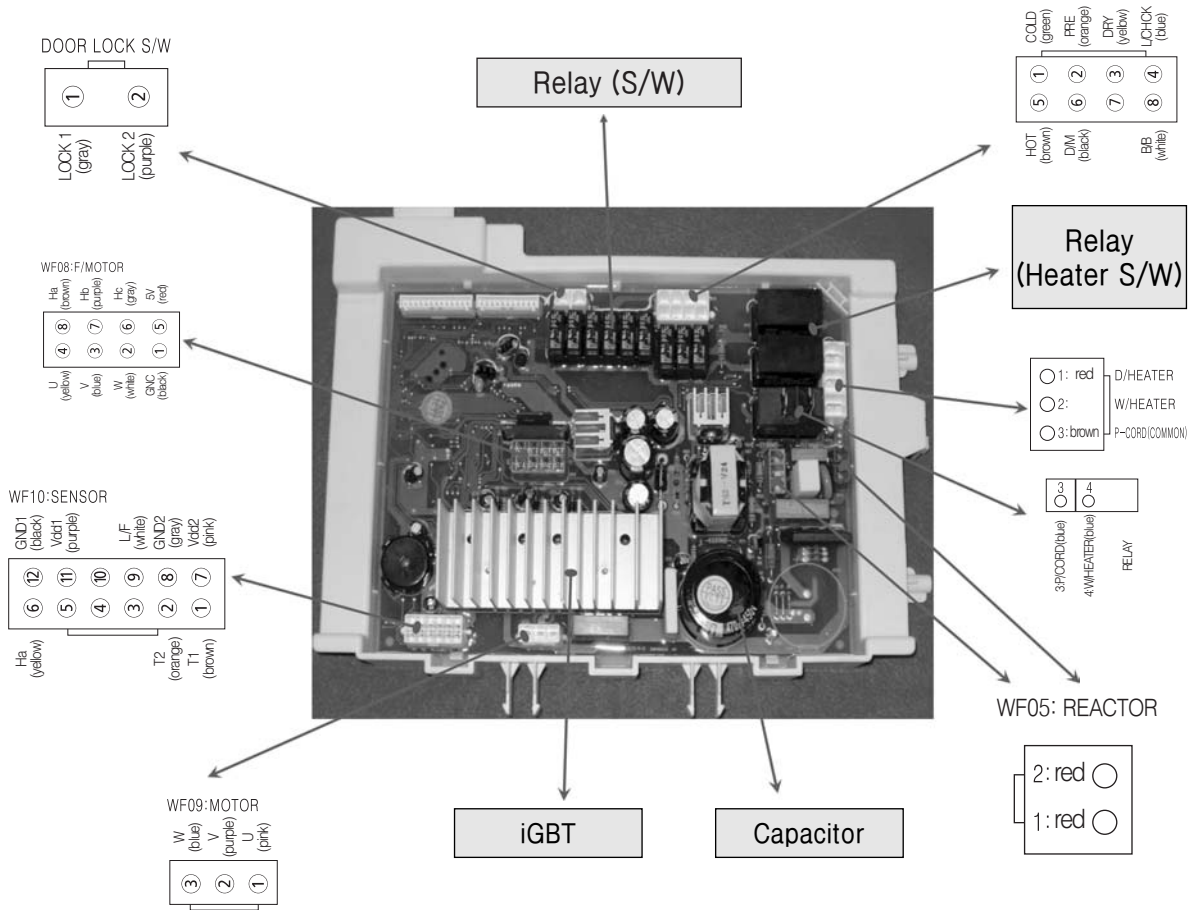

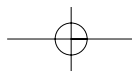

2. VALVE INLET

Classification	3-hole Valve and Hot Water Valve					
Code	3-hole: 3615415070, 3615415050, Hot Water: 3615415700, 3615414800					
Color	Gray					
Coil Resistance	4320 ~ 5280 Ω					
Use	Supplying water for washing/ pre-washing and bleach					
Appearance Structure						
Symptoms of Breakdown	Detailed Symptoms	Cause	Diagnosis of Defect	Solution	PCB Error Mode	
Water not supplied	Water supply not carried, only noise is heard	Water tap not opened	Check for tap opening.	Open water tap.	"E"	
		Coil short	Check if resistance between water supply valve terminals is within 4320-5280Ω.		"E"	
		Excessive foreign substances in SUS filter	Remove water supply hose and check for foreign substances in filter.	Clean out foreign substances from inside the filter.	"E"	
		Foreign substances in valve	-	Replace water supply valve.	"E"	
	Water supply not carried out without noise	Connector loosened	Visually check connector connection status.		Administer re-insertion.	"E"
		Coil short	Check if resistance between water supply valve terminals is within 4320-5280Ω.		Replace water supply valve.	"E"
Wiring short		Wiring short -> Conduction test			"E"	
Water is continuously supplied (inside tub)	Continuous water supply in power 'on' state	Defect in water level sensor	Refer to water level sensor defect check method.	Replace water level sensor.	"E2"	
		Defect in pressure hose	Check for blocking of holes in pressure hose.	Replace defect parts.	"E2"	
	Continuous water supply in power 'off' state	Defect in water supply valve	-		Replace water supply valve.	-
Others	Water leakage through sides	Defect in water supply valve assembly, etc.	Floater restraint, loosening -> S/W not working Check for leakage through the sides of water supply valve.	Replace water supply valve.	-	



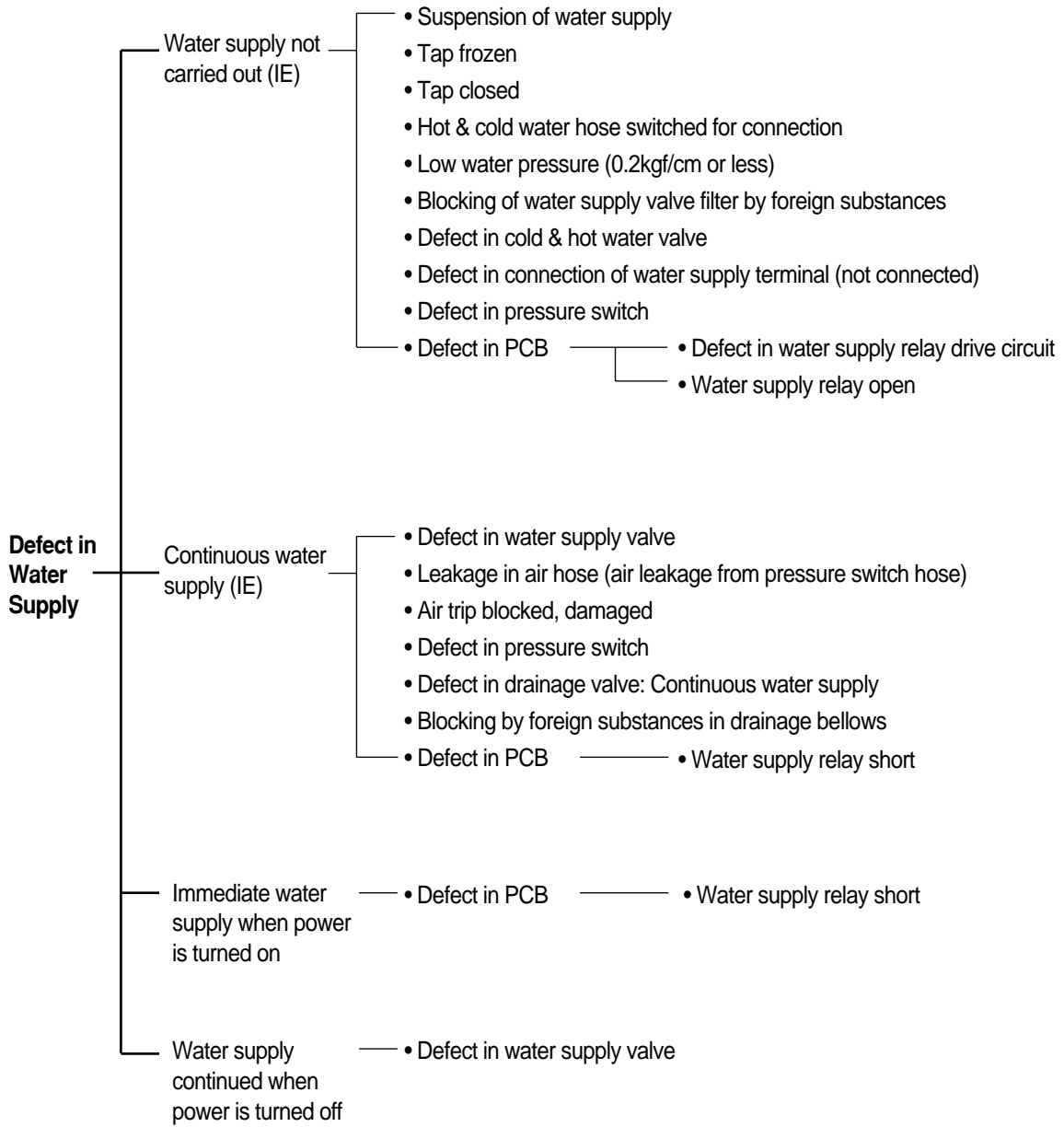

Symptoms of Breakdown	Inspection Spot	Inspection Method	Inspection Result	Problem Identified	Repair Method
Water supply not carried out		1) Suspension of water supply 2) Water tap locked 3) Cold-hot water hose incorrectly connected 4) If no defect is found, dismantle water supply hose and check water supply valve filter.	- Cold/ hot water hose switched - Large amount of rust, sand and dust, etc.	-Defect in cold/ hot water hose assembly -Defect in cleaning of water supply filter (blocked)	-Assemble cold/ hot water hose correctly. -Clean water supply filter.
	Water supply valve	1) Measure coil resistance in water supply valve. 2) Remove top cover and visually check for separation of water supply valve terminal connector and wiring short/ connection status. 3) In case water valve operation sound is heard, but water supply is not carried out, check for blocking of water supply valve or restraint on plunger.	-5.3kW or higher -Connector loosened/ not inserted -Electric wire short -Sound and defect in water supply due to foreign substances in bellows	-Coil short -Connection defect -Electric wire short -Structural defect in water supply valve	-Replace water supply valve. -Try reconnection or remove elements of connection defect. -Try reconnection or remove elements of connection defect. -Replace water supply valve.
	Pressure Switch	1) Check for 'E9' in display window.	-E9	-Loosening of pressure S/W terminal or electric wire short -Defect in pressure S/W	-Connect terminal of pressure S/W. -Connect terminal of PCB. -Replace pressure S/W.
Water supply not carried out	PCB	1. Check PCB pin connector insertion status. 2. Power is supplied to water supply valve terminal, but water supply is not administered.	Electric wire easily loosened when tugged PCB water supply circuit open, damaged (water supply relay operation not carried out)	Pin connector housing not inserted Defect in water supply circuit	Completely insert connector housing. Replace PCB.
Continuous water supply	PCB	1. Immediate supply when power is turned on	PCB water supply circuit or relay short (continuous conduction to valve)	Water supply relay short	Replace PCB.
	Water supply valve	1. Check if water supply is continuously carried out even if power is not on.	Water supply bellows blocked/ deformed	Defect in water supply valve	Replace water supply valve.
	Drainage drive motor (valve housing)	1. Check for normal operation of water supply valve/ water supply status. 2. Check if water is drained through drainage hose. 3. Check for foreign substances inside valve housing. 4. Check for foreign substances in drive motor wire. 5. Forcefully restore SUS wire.	-Not closed due to foreign substances inside drainage housing -Wire caught by foreign substances outside drive motor -Forced restoration not possible	-Foreign substances in valve housing -Foreign substances -Defect in drive motor restoration	-Remove foreign substances. -Remove foreign substance. -Replace drive motor.

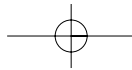

3. Water Level Sensor

1) Spec. of Water Level Sensor

	HEATER SAFETY	STEAM	RESET	LOW	MID	RINSE	ADD WATER	OVERFLOW
(kHz)	24.55	24.736	25.2	23.2	23.75	23.18	22.96	22.6

<p>O/F: Forced drainage is necessary as water level is high. When this level is reached, water supply must be stopped and drainage must be forcefully administered.</p>	<p>RESET :</p> <ol style="list-style-type: none"> 1. Spin-drying begins 30sec after drainage level reset is reached. 2. Heater operation level 	<p>Low: Small load of laundry, therefore considered to be water level of 'low'</p>
		<p>Medium: Large load of laundry</p>
		<p>Medium High: Water level for rinsing</p>
		<p>Safety: Door open possible Door opened only when water level is below safety level</p>

2) Breakdown Analysis

Symptoms	Detailed Symptoms	Cause	Diagnosis	Solution	PCB Error Mode
Continuous water supply	Water valve normal	Defect in pressure sensor hose	Check for holes.	Replace hose.	"E2"
		Blocking of pressure sensor hose	Visual checking	Remove foreign substances.	"E2"
"E9"	Occurrence in water level sensor 30kHz or higher	Connector loosened	Visually check connector connection status.	Administer re-insertion.	"E9"
		Wiring short	Wiring short -> conduction test		"E9"

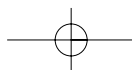

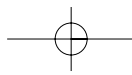

4. POWER CORD

1) Specification

Classification	Rated	Cord Thickness	Color	Code	Type	Length	Remarks
DEC	250V/15A	1.5sq	Gray	3611339340	LP-31 SJT	2.3m	-
DEC	125V/13A	1.5sq	Gray	3611340410	ULSJT	2.3m	-
DEC	250V/16A	1.5sq	Gray	3611339930	EU-2P	2.3m	-
DEC	125V/15A	2.0sq	Gray	3611339810	BSMI	2.3m	-



2) Assembly

- 4 embossed parts in cabinet
- > To prevent loosening after assembly
- > SS: 2 special screws
- > LG: Forced indentation

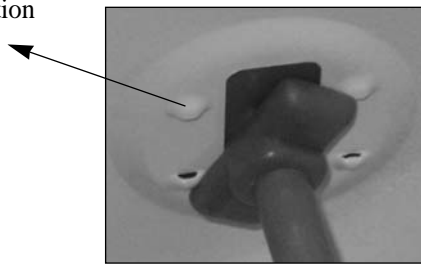

[Before]

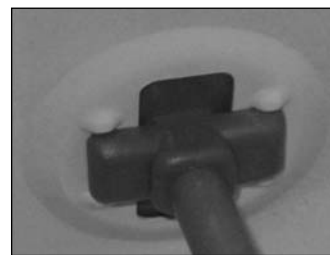

[After]

. CONNECTOR

- > #1806 Housing 3P Used: Using both ends only and not the hole in the middle (materials highly resistant to flame)
- > To prevent fire caused by high current

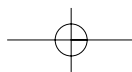

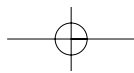

5. DOOR LOCK SWITCH

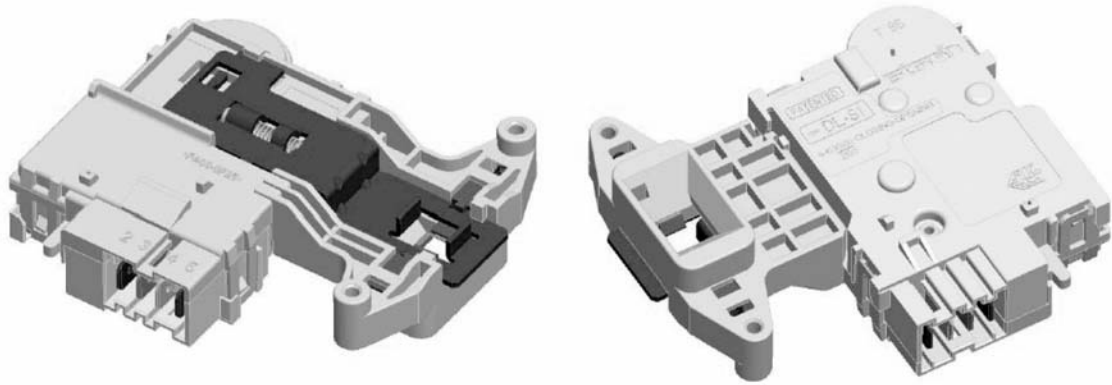

PART CODE	DESCRIPTION
3619047200	DOOR LOCK DL-S1 250V PTC-SOLENOID TYPE
3619041210	DOOR LOCK DL-S1 125V L6A BITRON

1) DOOR LOCK S/W

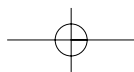
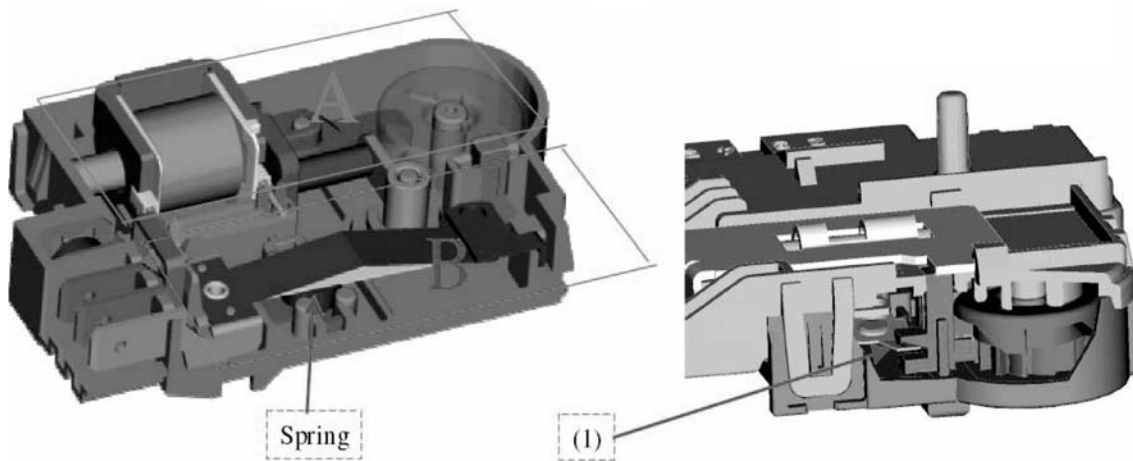

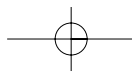

4) Diagnosis of Defect

Symptoms	Detailed Symptoms	Cause	Diagnosis of Defect	Solution	Error Mode
Ticking noise	'Tick' during initial operation and 'tick-tick' during temporary suspension: 'DF' type only	Normal noise	Normal sound generated during solenoid operation when 'sliding CAM' is locked/ unlocked to close or open door.		—
LE'	Continuous occurrence of 'tick' noise and 'LE': 'DF' type only	Connector loosened	Visually checking connector connection status	Insert connector.	"LE"
		Terminal loosened from connector	Referring to door lock S/W dismantling and checking methods below	Insert connector. S/W 4 or 5 terminal	"LE"
		Door not completed closed	-	Completely close door.	"LE"
		Abnormality in hook of door	-	Replace door AS.	"LE"
		Defect in catch CAM operation	Occurrence of continuous 'tick' noise unlike normal sound	Replace door S/W.	"LE"
	1. 'LE' occurrence without 'tick' noise in 'DF' type	Connector loosened	Visually checking connector connection status	Insert connector.	"LE"
		Terminal loosened from connector	Referring to door lock S/W dismantling and checking methods below	Insert terminal. S/W 2 or 3 terminal	"LE"
		Breaking of solenoid coil	Referring to picture below	Replace door S/W.	"LE"
	Door does not open.	Power failure, forced power off during operation	PCB MICOM' cannot open door in case of power failure or forced power S/W off during operation. Door can be opened in the max. of 5min.		
No power failure and power on		Water in drum	Checking if water level is higher than safety level	Door opens after drainage.	—
		Inside the drum hot	Prevention of door opening to prevent burn caused by hot laundry after drying		
Others		Door does not open normally in case of loosening of connector/ terminal and breaking of solenoid coil during operation. Administer measures after test according to the following method.			

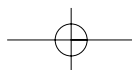

1. Heater

1) Spec of Heater of Washing Machine

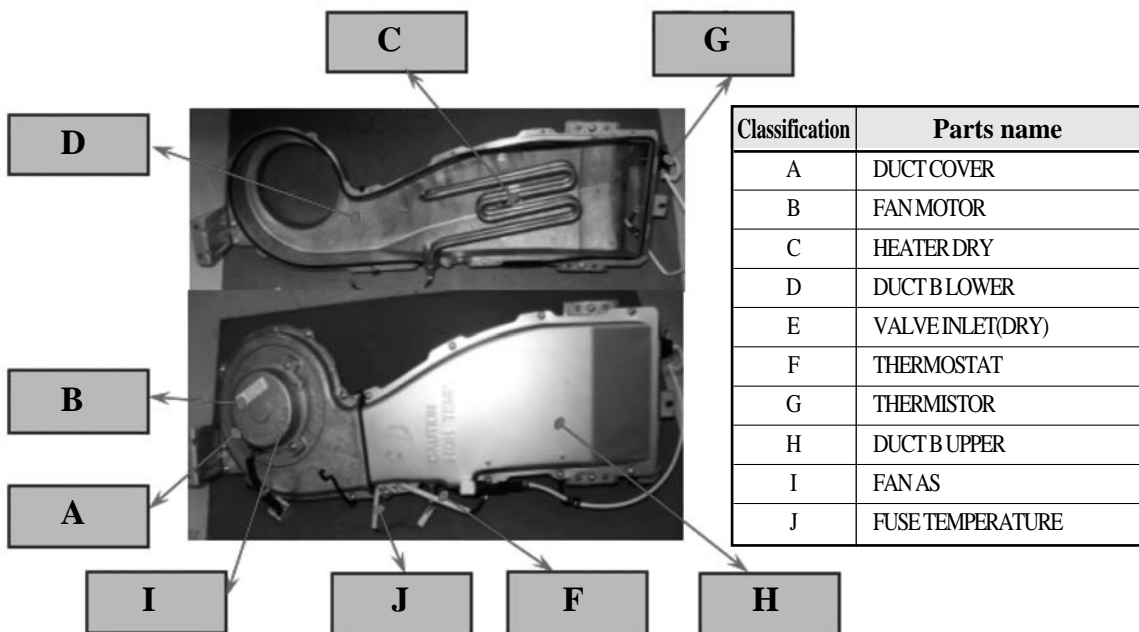
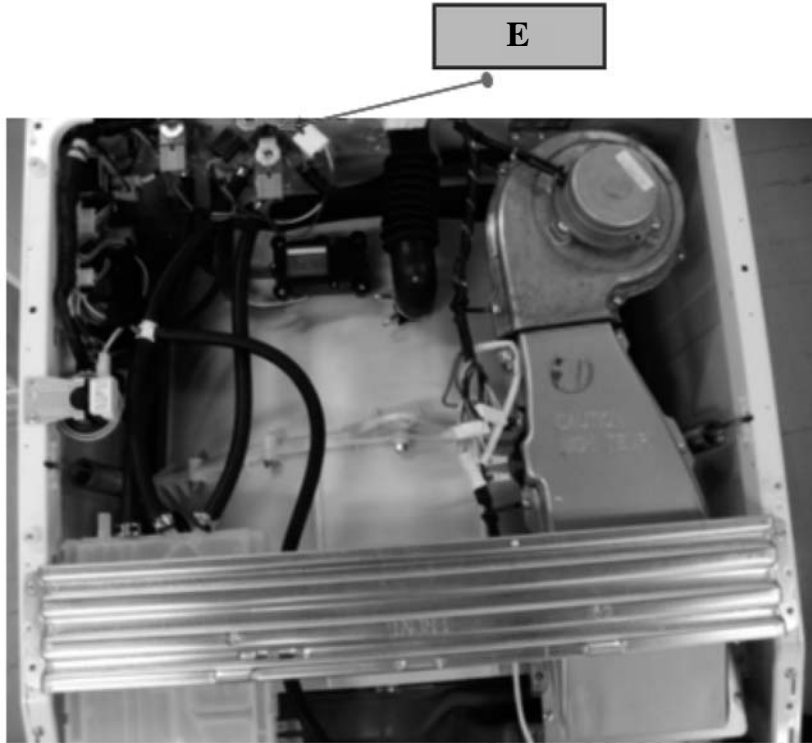

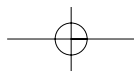

2) Dry Function Diagram

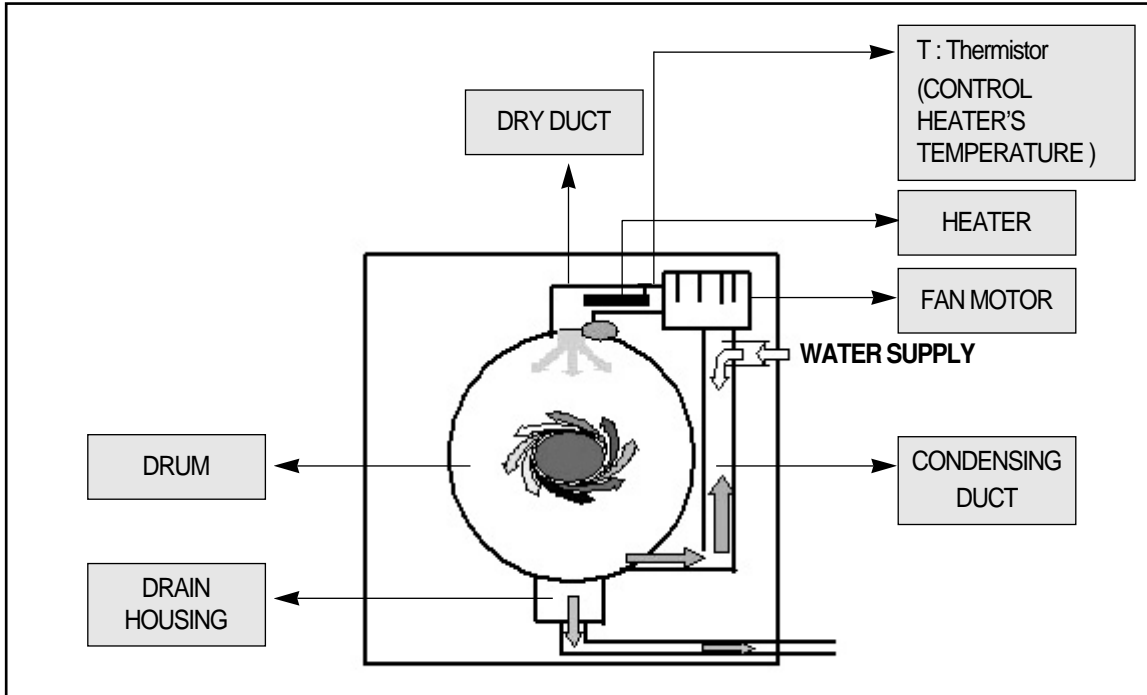

While rotating DRUM, DRY HEATER apply heat to air and FAN blows it into DRUM evaporating water in the laundry.

- Evaporated water is sucked into CONDENSING DUCT, and condensed in DUCT contacting WATER SUPPLY (condensed water is extracted through DRAIN HOUSING).
- Dry function is performed by continuous repetition of evaporating and condensing circulation as above.

3) Temp- Time Graph During Dry Cycle

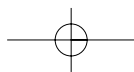
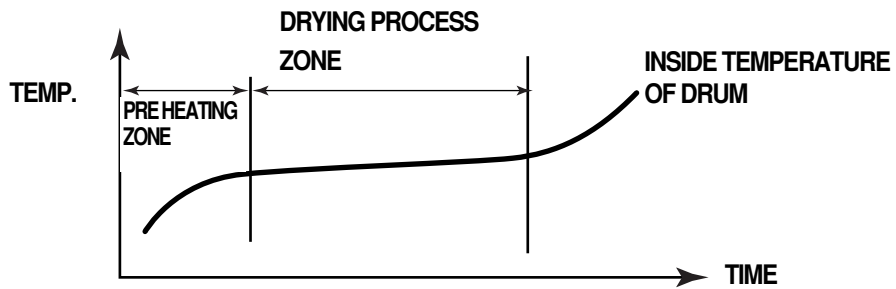

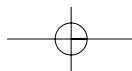

4) Dry Course

COURSE	DRY COURSE
LOW TEMP.	Heater control temperature is 60°C On/70°C Off Drying Time is 110min according to Load Sensing Data
IRON	Heater control temperature is 95°C On/105°C Off, with good condition for ironing Drying Time is 60min according to Load Sensing Data
Cupboard	Heater control temperature is 95°C On/105°C Off, drying time is 150 min
STRONG	Heater control temperature is 95°C On/105°C Off, drying time is 200 min
SELECTING TIME	Heater control temperature is 95°C On/105°C Off, customer can select the drying time out of 1:00, 1:30, 2:00

In order to check the drying temperature during process going on : --> press the "DRY" button, the display shows as below.

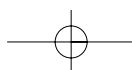
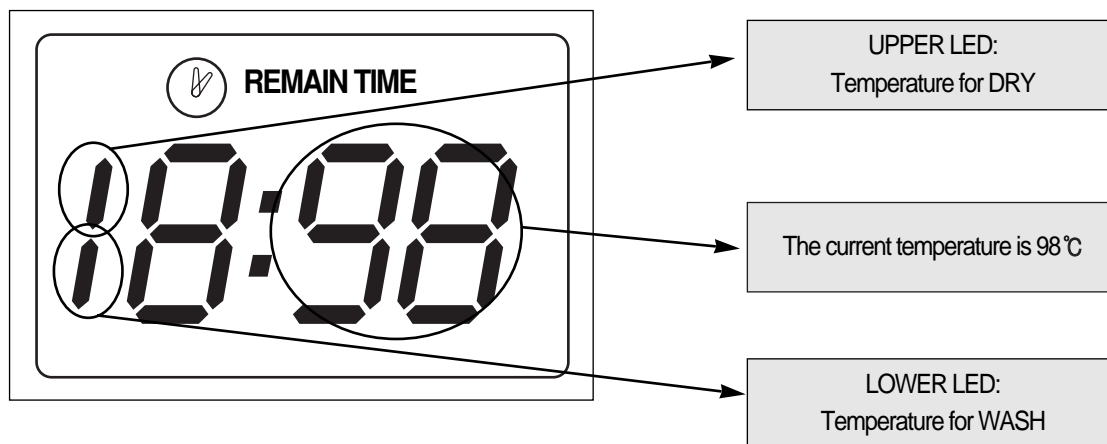

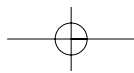

5) TROUBLE SHOOTING OF DRY SYSTEM

◆ HEATER DRY

Function : heating the air during dry

- FAILURE MODE : * "H7" - The air cannot be heated to 10°C during 2 min.
- CHECKING METHOD : * Check the resistance of heater coil and replace with new one.

◆ Thermistor

Function : sensing the air temperature.

- FAILURE MODE : * The air cannot be heated even though water is supplied.
 - * "H1" - shot or cut-off
 - * "H3" - air temp. is reached over 150°C
- CHECKING METHOD : * Check the resistance of thermistor, replace with new one.

◆ FUSE TEMPERATURE

function : protecting from the fire hazard or overheating, if the temp., rises over 128°C, power supply will be cut-off.

- Pictures



- FAILURE MODE : Dry is not performed.
- CHECKING METHOD : Check if fuse is short, and replace with new one.

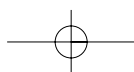

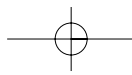

◆ SWITCH THERMOSTAT(BIMETAL)

function : control the duct temperature, if the temp reached over 150°C, all power supply will be cut. and if the temp go down 120°C the power will be ON.

protecting overheating by cutting off heater power supply if the temperature rises over 150°C, and reoperating heater by connecting heater power supply if the temperature falls under 120°C.

• OPERATING TEMPERATURE

OPEN TEMPERATURE(OFF)	150°C ± 5°C
CLOSE TEMPERATURE(ON)	120°C ± 5°C

• PICTURE



◆ UNIT FAN MOTOR

function : circulating the inside air during dry process.

• SPEC

ITEMS		SPEC
RATING VOLTAGE		24V
RPM	MOTOR	3700 ± 10%
	DUCT FAN AS	1900 ± 10%
ROTAING DIRECTION		CW

• PICTURE

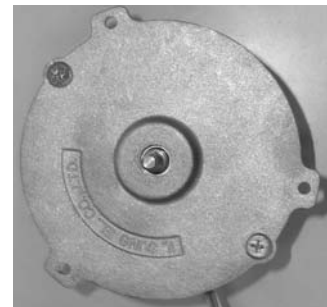

- FAILURE MODE : * E3 shown : FAN MOTOR cannot work.
- CHECKING METHOD : Check the FAN MOTOR is short, and replace with new one.

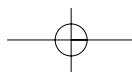

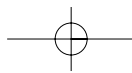

6) LACK OF DRY PERFORMANCE

• Situation : after drying, the clothes still get wet.

- cause) ☞ The laundry amount is more than the recommendation capacity 7.0kg.
 ☞ Condensing cold water is not supplied.
 ☞ Clogging Bellows Duct results in poor air circulation.

checking method)

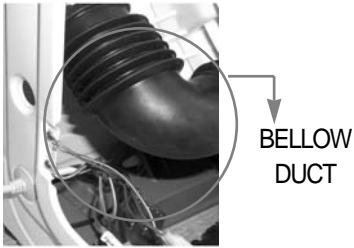
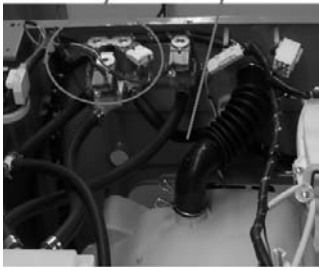
part name	checking point	checking results	judge	repair method
BELLOWS DUCT		clogging bellows duct	heater was overheated owing to poor air circulation	clean the bellow duct
VALVE INLET +Condensing HOSE		no water supply from inlet valve	VALVE INLET connector slipped out	connect normally
			VALVE INLET broken	replace valve inlet
			ill-connection of condensing hose to duct pipe	connect normally

• Situation after drying, the clothes was soaked and hot.

- cause) ☞ The dry is done from bad spin performance because of unbalance.
 ☞ no spin was done before the dry had started.

• Situation : PCB shows "H1" or "H3".

- cause) ☞ Thermistor is broken.
 ☞ Thermistor is short or cut-off.

countermeasures) ☞ replace the Thermistor.

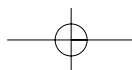

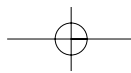

• Situation : PCB shows "H7".

cause) ⚡ Dry heater is cut-off.
 ⚡ Fuse temp. is cut-off.

repaire method) ⚡ replace the Dry heater.
 ⚡ replace the Fuse temp.

checking point	part name	checking results	repaire method
	HEATER	dry Heater is short or cut-off.	replace the dry Heater.
	SENSOR TEMP.	Thermistor is short or cut-off.	replace the Thermistor.
	FUZE TEMP.	FUZE TEMPERATURE is cut-off.	replace the FUZE TEMPERATURE.

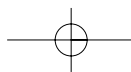

Washing Heater Temp. Sensor Table

R25 : 11.981KΩ ± 4.04%
 R80 : 1.704KΩ ± 3%
 B25/100 : 3760K ± 1%

TEMP	MIN	NORMAL	MAX	TEMP	MIN	NORMAL	MAX	TEMP	MIN	NORMAL	MAX	TEMP	MIN	NORMAL	MAX
℃	KΩ	KΩ	KΩ	℃	KΩ	KΩ	KΩ	℃	KΩ	KΩ	KΩ	℃	KΩ	KΩ	KΩ
-40	282.914	298.650	314.387	0	34.352	35.975	37.599	40	6.403	6.653	6.903	81	1.603	1.653	1.703
-39	266.642	281.416	296.191	1	32.776	34.318	35.861	41	6.169	6.409	6.648	82	1.555	1.603	1.652
-38	251.432	265.311	279.190	2	31.284	32.749	34.214	42	5.946	6.176	6.405	83	1.508	1.556	1.603
-37	237.208	250.252	263.296	3	29.869	31.262	32.655	43	5.732	5.952	6.172	84	1.463	1.510	1.556
-36	223.900	236.165	248.430	4	28.528	29.852	31.177	44	5.527	5.738	5.949	85	1.419	1.464	1.509
-35	211.440	222.978	234.516	5	27.256	28.516	29.776	45	5.320	5.523	5.725	86	1.377	1.421	1.465
-34	199.683	210.537	221.392	6	26.044	27.242	28.440	46	5.131	5.325	5.518	87	1.336	1.379	1.422
-33	188.669	198.885	209.101	7	24.893	26.033	27.174	47	4.949	5.135	5.321	88	1.297	1.339	1.381
-32	178.347	187.967	197.587	8	23.801	24.887	25.972	48	4.774	4.953	5.131	89	1.259	1.300	1.342
-31	168.668	177.731	186.793	9	22.764	23.798	24.831	49	4.607	4.778	4.950	90	1.222	1.262	1.302
-30	159.588	168.129	176.670	10	21.780	22.764	23.748	50	4.443	4.608	4.772	91	1.186	1.226	1.265
-29	150.999	159.049	167.099	11	20.836	21.773	22.710	51	4.289	4.447	4.605	92	1.152	1.191	1.229
-28	142.937	150.527	158.117	12	19.939	20.832	21.725	52	4.141	4.292	4.444	93	1.119	1.157	1.194
-27	135.366	142.526	149.685	13	19.087	19.938	20.788	53	3.999	4.144	4.290	94	1.087	1.124	1.161
-26	128.253	135.009	141.766	14	18.277	19.088	19.899	54	3.862	4.002	4.142	95	1.057	1.093	1.129
-25	121.566	127.945	134.324	15	17.506	18.279	19.052	55	3.722	3.856	3.990	96	1.027	1.063	1.098
-24	115.230	121.252	127.274	16	16.770	17.507	18.244	56	3.595	3.723	3.852	97	0.999	1.033	1.067
-23	109.271	114.959	120.647	17	16.069	16.772	17.475	57	3.473	3.596	3.720	98	0.971	1.005	1.038
-22	103.665	109.039	114.413	18	15.402	16.072	16.743	58	3.355	3.474	3.593	99	0.944	0.977	1.010
-21	98.387	103.467	108.547	19	14.767	15.407	16.046	59	3.243	3.357	3.471	100	0.918	0.950	0.982
-20	93.416	98.220	103.024	20	14.162	14.773	15.383	60	3.133	3.243	3.353	101	0.893	0.924	0.955
-19	88.603	93.141	97.679	21	13.576	14.158	14.741	61	3.029	3.135	3.240	102	0.868	0.899	0.930
-18	84.072	88.361	92.649	22	13.018	13.574	14.130	62	2.929	3.030	3.132	103	0.845	0.875	0.905
-17	79.806	83.860	87.914	23	12.486	13.017	13.548	63	2.833	2.930	3.028	104	0.822	0.851	0.881
-16	75.788	79.622	83.456	24	11.980	12.487	12.993	64	2.740	2.834	2.928	105	0.799	0.827	0.856
-15	72.000	75.628	79.255	25	11.497	11.981	12.465	65	2.654	2.744	2.835	106	0.777	0.805	0.833
-14	68.408	71.840	75.272	26	11.037	11.499	11.962	66	2.569	2.656	2.743	107	0.756	0.784	0.811
-13	65.021	68.270	71.518	27	10.598	11.040	11.482	67	2.487	2.571	2.654	108	0.736	0.763	0.790
-12	61.825	64.902	67.978	28	10.179	10.601	11.024	68	2.408	2.489	2.569	109	0.716	0.743	0.769
-11	58.810	61.724	64.637	29	9.780	10.183	10.587	69	2.333	2.410	2.487	110	0.697	0.723	0.749
-10	55.963	58.724	61.485	30	9.400	9.786	10.172	70	2.258	2.332	2.407	111	0.679	0.704	0.729
-9	53.214	55.829	58.443	31	9.036	9.405	9.775	71	2.187	2.259	2.331	112	0.661	0.686	0.710
-8	50.620	53.097	55.573	32	8.688	9.042	9.395	72	2.119	2.188	2.257	113	0.644	0.668	0.692
-7	48.171	50.517	52.864	33	8.356	8.695	9.033	73	2.054	2.120	2.187	114	0.627	0.651	0.674
-6	45.857	48.081	50.305	34	8.039	8.363	8.686	74	1.991	2.055	2.119	115	0.610	0.634	0.657
-5	43.670	45.779	47.889	35	7.737	8.047	8.357	75	1.928	1.990	2.051	116	0.595	0.617	0.640
-4	41.594	43.594	45.594	36	7.448	7.744	8.041	76	1.869	1.928	1.988	117	0.579	0.602	0.624
-3	39.630	41.528	43.425	37	7.170	7.455	7.739	77	1.812	1.869	1.927	118	0.565	0.586	0.608
-2	37.773	39.574	41.375	38	6.905	7.178	7.450	78	1.758	1.813	1.868	119	0.550	0.572	0.593
-1	36.016	37.725	39.435	39	6.652	6.912	7.173	79	1.705	1.758	1.811	120	0.536	0.557	0.578

Day Heater Temp. Sensor Table

R40 : 26.065KΩ ± 3%
 R100 : 3.3KΩ ± 11.1%
 B40/100 : 4025K ± 2%

T(°C)	Rmin	Rcent	Rmax	T(°C)	Rmin	Rcent	Rmax	T(°C)	Rmin	Rcent	Rmax
0	142.55	162.21	184.12	56	12.980	14.066	15.203	112	2.211	2.343	2.477
1	135.55	154.09	174.72	57	12.520	13.557	14.643	113	2.149	2.279	2.411
2	128.93	146.41	165.85	58	12.078	13.069	14.105	114	2.090	2.217	2.347
3	122.68	139.17	157.48	59	11.655	12.601	13.591	115	2.032	2.158	2.285
4	116.76	132.32	149.59	60	11.248	12.153	13.097	116	1.977	2.100	2.225
5	111.17	125.86	142.13	61	10.857	11.722	12.624	117	1.923	2.043	2.166
6	105.87	119.74	135.09	62	10.483	11.309	12.171	118	1.870	1.989	2.110
7	100.86	113.96	128.45	63	10.123	10.913	11.736	119	1.820	1.936	2.055
8	96.12	108.50	122.16	64	9.777	10.533	11.319	120	1.771	1.885	2.002
9	91.62	103.32	116.22	65	9.445	10.168	10.919	121	1.723	1.836	1.950
10	87.37	98.43	110.61	66	9.125	9.817	10.535	122	1.678	1.788	1.900
11	83.33	93.79	105.30	67	8.818	9.481	10.167	123	1.633	1.741	1.852
12	79.51	89.40	100.27	68	8.524	9.157	9.813	124	1.590	1.696	1.805
13	75.88	85.24	95.51	69	8.240	8.846	9.474	125	1.548	1.652	1.759
14	72.44	81.30	91.01	70	7.967	8.548	9.148	126	1.508	1.610	1.715
15	69.17	77.56	86.74	71	7.705	8.261	8.834	127	1.468	1.569	1.672
16	66.07	74.01	82.70	72	7.452	7.985	8.533	128	1.430	1.529	1.630
17	63.13	70.65	78.87	73	7.210	7.719	8.244	129	1.393	1.490	1.590
18	60.34	67.46	75.24	74	6.976	7.464	7.966	130	1.357	1.453	1.550
19	57.68	64.43	71.80	75	6.751	7.218	7.699	131	1.323	1.416	1.512
20	55.16	61.56	68.53	76	6.534	6.982	7.442	132	1.289	1.381	1.475
21	52.76	58.83	65.43	77	6.326	6.755	7.195	133	1.256	1.346	1.439
22	50.48	56.24	62.49	78	6.125	6.536	6.957	134	1.225	1.313	1.404
23	48.31	53.77	59.70	79	5.931	6.325	6.729	135	1.194	1.281	1.370
24	46.25	51.43	57.05	80	5.745	6.123	6.509	136	1.164	1.249	1.337
25	44.28	49.20	54.53	81	5.565	5.927	6.297	137	1.135	1.219	1.305
26	42.41	47.08	52.13	82	5.392	5.739	6.093	138	1.107	1.189	1.274
27	40.63	45.07	49.86	83	5.225	5.558	5.897	139	1.080	1.160	1.244
28	38.94	43.15	47.69	84	5.064	5.383	5.708	140	1.053	1.132	1.215
29	37.32	41.32	45.64	85	4.909	5.215	5.526	141	1.027	1.105	1.186
30	35.78	39.58	43.68	86	4.759	5.053	5.351	142	1.002	1.079	1.158
31	34.31	37.93	41.82	87	4.615	4.896	5.182	143	0.978	1.053	1.131
32	32.91	36.35	40.04	88	4.476	4.746	5.019	144	0.954	1.028	1.105
33	31.58	34.85	38.36	89	4.341	4.600	4.862	145	0.931	1.004	1.080
34	30.31	33.41	36.75	90	4.212	4.460	4.711	146	0.909	0.980	1.055
35	29.09	32.05	35.22	91	4.086	4.325	4.566	147	0.887	0.958	1.031
36	27.93	30.75	33.76	92	3.965	4.194	4.425	148	0.866	0.935	1.007
37	26.83	29.50	32.37	93	3.849	4.068	4.289	149	0.846	0.914	0.984
38	25.77	28.32	31.04	94	3.736	3.947	4.159	150	0.826	0.893	0.962
39	24.76	27.19	29.77	95	3.627	3.829	4.033				
40	23.80	26.11	28.57	96	3.522	3.716	3.911				
41	22.87	25.07	27.42	97	3.420	3.606	3.793				
42	21.99	24.09	26.32	98	3.322	3.501	3.680				
43	21.15	23.15	25.27	99	3.227	3.399	3.571				
44	20.34	22.25	24.27	100	3.135	3.300	3.465				
45	19.57	21.39	23.31	101	3.043	3.205	3.367				
46	18.84	20.57	22.40	102	2.954	3.113	3.272				
47	18.13	19.78	21.53	103	2.867	3.024	3.180				
48	17.46	19.03	20.69	104	2.784	2.937	3.092				
49	16.81	18.31	19.90	105	2.704	2.854	3.006				
50	16.19	17.62	19.13	106	2.626	2.774	2.923				
51	15.60	16.96	18.40	107	2.551	2.696	2.842				
52	15.03	16.33	17.71	108	2.478	2.621	2.764				
53	14.48	15.73	17.04	109	2.408	2.548	2.689				
54	13.96	15.15	16.40	110	2.340	2.477	2.616				
55	13.46	14.60	15.79	111	2.274	2.409	2.546				

7. HEATER

1) Spec of Heater of Washing Machine

	WASH			
MAKER	IRCA	IRCA	IRCA	IRCA
RATED	220V	230V	130V	110V
CONSUMPTION POWER	2000W	2000W	1000W	1000W
PART CODE	3612802400	3612802410	3612802440	3612802430
	DRYER			
MAKER	IRCA	IRCA	IRCA	IRCA
RATED	220V	230V	120V	110V
CONSUMPTION POWER	2100W	2100W	1200W	1200W
PART CODE	3612800900	3612801400	3612802100	3612801300

Temp. Fuse of Washing Heater (184°C CUT OFF TYPE)

: Located inside heater to prevent fire, etc. caused by heating without water due to breakdown of water level sensor, etc.

: Cut-off in app. 1min in case of overheating, heater temp. of app. 270°C

: Washing heater must be used under water.

※ Wash Heater

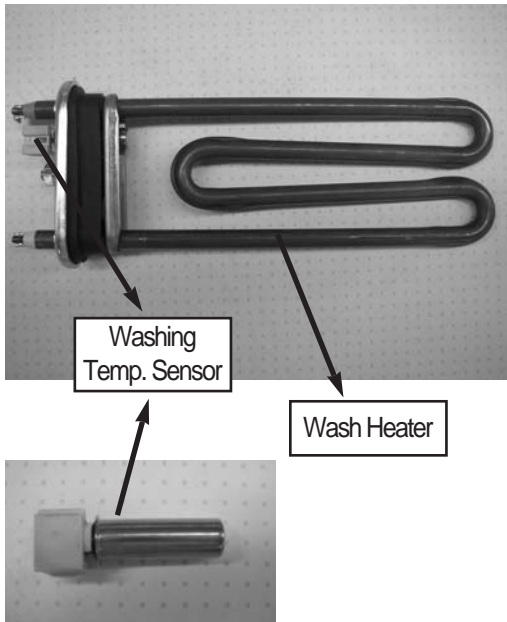

※ Day Heater

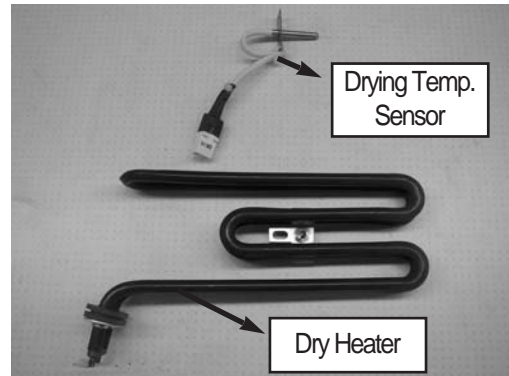

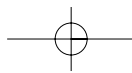

2) Breakdown Diagnosis

Breakdown Symptoms	Cause	Diagnosis	Solution	PCB Error Mode
Washing water not heated (common for drum)	Wiring short	Check for short	Connect the cut-off part.	"H6"
	Washing heater or temp. fuse short	Check for short: Normal if 23.3~25.7ohm between both terminals of washing heater	Replace washing heater.	"H6"
	Connector/ terminal loosening	Check for loosening: Common for drum	Insert terminal.	"H6"
	Defect in washing heater temp. sensor	Measuring resistance between both terminals of sensor:	Replace temp. sensor.	"H2"
Overheating of washing water	Defect in washing heater temp. sensor	Measuring resistance between both terminals of sensor:	Replace temp. sensor.	"H2" or "H4"

Heater Replacement

* How to Replace Washing Heater and Temp. Sensor

1. Dismantling Connector



2. Loosening Earth and Heater Nuts



3. Replacing Heater and Temp. Sensor



4. Administer assembly in reverse order and make sure to fasten heater nuts first before the earth nuts.

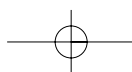

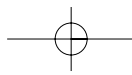

7. HEATER

1) Structure of BLDC Motor

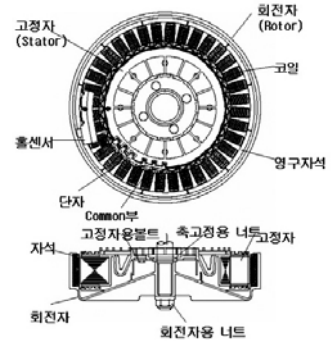
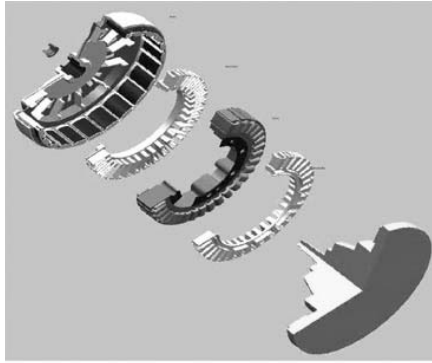
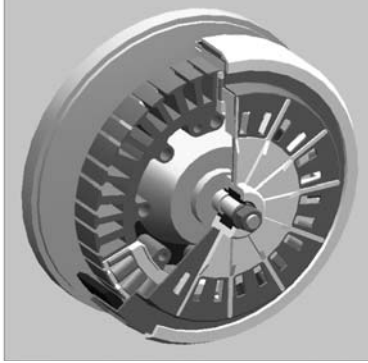

BLDC MOTOR

2) Power Transmission System of BLDC Motor

Sequence diagram of BLDC MOTOR

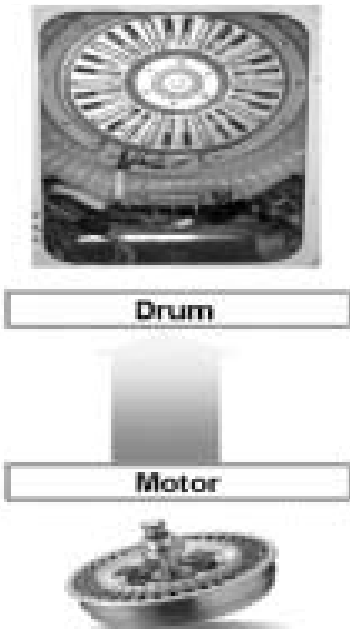

Direct Drive Motor

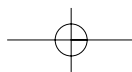
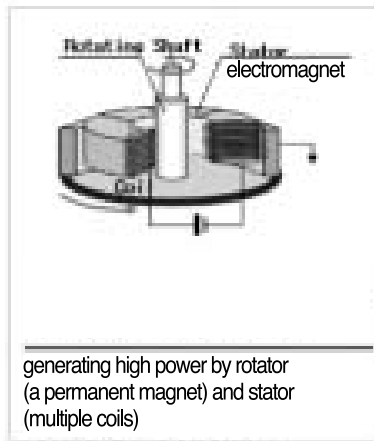

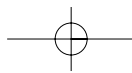

3) Specification

Classification	Item	BLDC : DD Motor
1. General	Rated Voltage	V _m = 310 [Vdc], Hall IC Voltage 5 [Vdc]
	Insulating Structure	Type B, insulator method
	External Appearance	Shaft connection and stator connection structure, Air-gap : 1mm
	No. of Poles	24 poles, Core: 36 slots, Layer: [30mm]
2. Performance	Consumption Power	390[W]±10[%], during washing (picked value)
	RPM	During Washing: 45RPM, During Spin-drying:1300RPM
	Output Characteristics	Torque: 300Kgf.cm (washing: 45rpm) Current: 1.5A (washing: 45rpm), 2.5A (spin-drying: 800rpm) AC Input Terminal - Washing: 250Wo, Spin-drying: 380Wo
3. Structure	Stator Resistance	ø265x30H
		U(blue) - V(purple) : 13.8Ω[at 75°C] V(purple) - W(pink) : 13.8Ω[at 75°C] W(pink) - U(blue) : 13.8Ω[at 75°C] cf) Motor resistance at ambient temp. of 0 ~ 35°C 7.04 ~ 8.1Ω
	Rotor	Magnet : 24 segments, bracket, serration
	Hall IC	2-sensor Control Type, Top Central Angle: 7.5 degrees Signal Error Angle (phase difference): 90±5 degrees (based on electric angle)

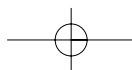

8. WIRING DIAGRAM

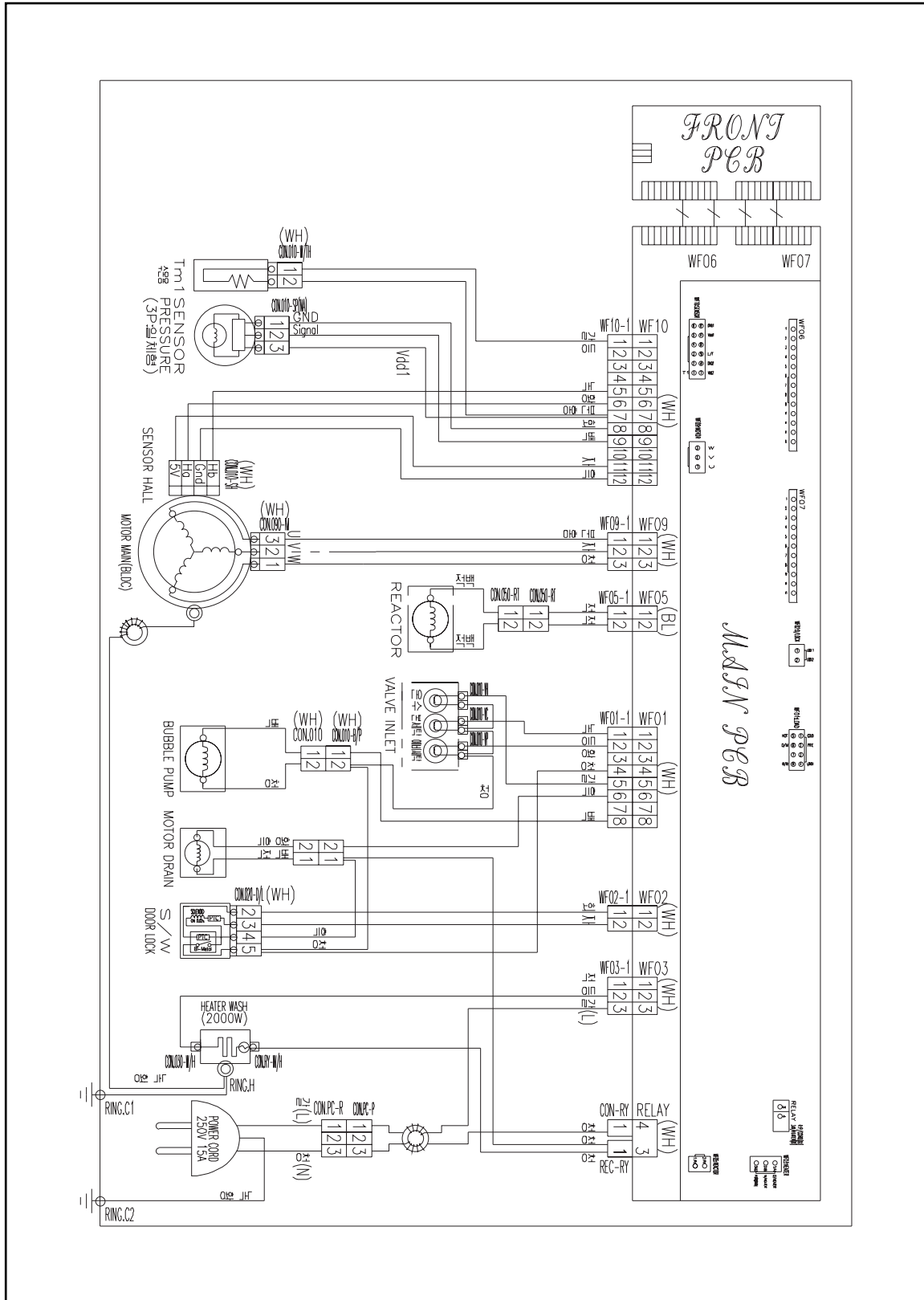

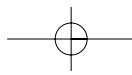

9. TROUBLE SHOOTING REGARDING DRAIN

1) Structure of Dran Parts by TUB

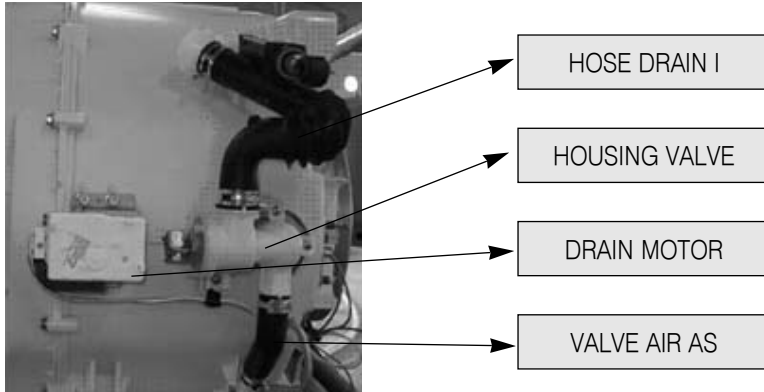

2) Checking Methods

- Situation :
 - * "OE" is shown on PCB.
 - * Not finishing drain during 10 min.
 - * The water level can not reach to RESET POINT during 10 min of drain.

Checking Methods	Replacing methods
* Check the hose drain O condition; twisted or frozen.	* replace HOSE DRAIN O
* Check the hose drain O condition, blocked.	* clean the inside of Filter.
* DRAIN MOTOR is broken.	* replace DRAIN MOTOR

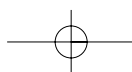

10. INSTALLATION GUIDE

1) Related Parts and Configuration

PARTS NAME	FIGURES	REMARKS
FIXTURE UP/DOWN AS		FIXTURE UP AS (3612008200) : L= 109mm FIXTURE DOWN AS (3612008300) : L=143mm
UNIT SERVICE WRENCH		① Remove Fixture UP/DOWN AS ② Adjust Leg
LEG ADJUST AS		

2) INSTALLATION PROCESS

① Remove the FIXTURE UP/DOWN AS

Removal Method	Remarks
	<ul style="list-style-type: none"> ☞ Disassemble the FIXTURE UP/DOWN AS by turning CCW direction. ☞ Please keep FIXTURE UP/DOWN AS for later use. ☞ When fixing FIXTURE UP/DOWN AS, turn it CW direction.

② Insert CAP HOLDER(4EA) after removing FIXTURE UP/DOWN AS.

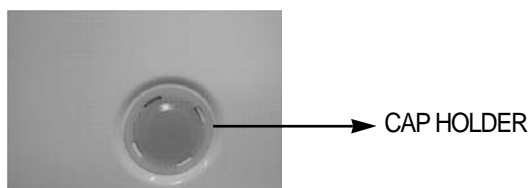

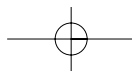

③ Please install the DRUM WASHING MACHINE properly on even and hard floor as below.

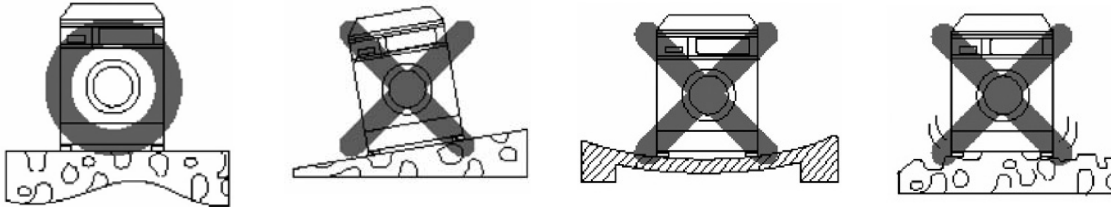

④ Adjust the level of washer using LEG ADJUST AS.

Adjusting Method	Remarks
	<ul style="list-style-type: none"> ☞ If turned CW, the LEG ADJUST AS moves the washer upward. ☞ If turned CCW, the LEG ADJUST AS moves the washer downward.

⑤ After adjusting level, fix SPECIAL BOLT.

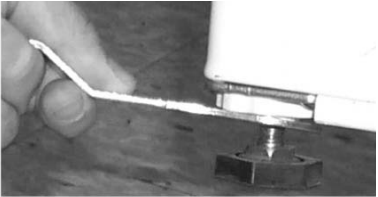
Adjusting Method	Remarks
	<p>☆ Please fix the SPECIAL BOLT by rotating it CCW in order to prevent washer vibration.</p>

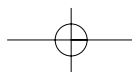

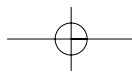

11. ATTENTION POINT WITH SERVICING

No	Item	Part Name	Checking Point
1	Replacing Thermistor Dry	Thermistor Dry	Keep the Packing from separating (Hold Packing when replacing) Keep the Packing from folding
2	Replacing Duct B As & Duct Pipe	DUCT B AS & DUCT PIPE	Check the sealing between Duct Pipe & Duct B AS
3	Replacing & Repairing Inlet Valve	Inlet Valve	Use only screw M4*8 for fixing Inlet Valve
4	Replacing Hose Drain	Hose Drain	Keep the sealing condition of Tub O tightly
5	Replacing HOSE A,B,C	HOSE A,B,C	Check the assembling order between INLET BOX & Hose A,C : Pre Wash-Cold
6	Replacing Heater Wash	Heater Wash	Unfastening the nut for fixing earth first then unfasten the nut for fixing heater At assembling the heater dry, check if the assembling condition between fixture heater is tight.(little gap on left & right) At fastening the nut for fixing the heater wash, keep the protrusion length of bolt to 10~12mm. (if under 10mm, water can leak, and if over 12mm, fixture heater can deform)
7	Replacing "Thermistor Wash"	Thermistor Wash	Unfasten the Nut for fixing heater, replace the thermistor, and fasten the nut for fixing heater
8	Assembling "Hinge Door"	Hinge Door	At fastening screw for fixing Door AS, be careful so that scratching at the related parts does not happen : If the scratching happens, it is possible to be claimed about appearance damage
9	(Dis)assembling "Door AS"	Door AS	Be careful about the up/down direction of Door Glass : Keep the indication point of the part code downward.
10	(Dis)assembling "Motor AS"	MOTOR AS	To avoid the injury on the hand, grip the rim of the rotor At initiating the assembling operation of the stator, grip the stator and fasten the screw; at unfastening the screw, grip the stator so that it does not fall.
11	Damper AS	Damper AS	Fixed 4 Dampers with spring when assemble.

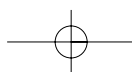

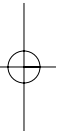
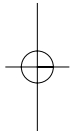
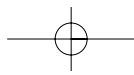

S/M NO. :

DAEWOO ELECTRONICS CORP.

686, AHYEON-DONG MAPO-GU SEOUL, KOREA

C.P.O. BOX 8003 SEOUL, KOREA

TELEX: DWELEC K28177-8

CABLE: "DAEWOOELEC"

PRINTED DATE: Apr. 2008

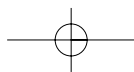

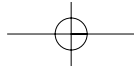

ABOUT THIS MANUAL

VISION CREATIVE, INC.

중구 남대문로 5가 526
대우제단빌딩 16층

담 당	이영배 님	TEL
MODEL	DWD-T120R(S/M)_드럼업세탁기	
접 수	2008.04.07 (총 72p)	
일 정	1차	6차
	2차	7차
	3차	8차
	4차	9차
	5차	10차
제 판		인쇄
규 격		
MEMO 08.04.07-전체신규(73page) 08.04.16-24p, 25p, 26p, 27p, 28p, 29p, 31p, 61p수정_신규 8p 08.08.11-4p, 5p, 7p, 12p, 14p, 16p, 20p, 22p, 42p, 61p수정_신규 10p 08.08.13-15p, 16p 수정_신규 2p 08.10.13-표2, 12p, 14p, 16p, 20p, 22p, 42p, 43p, 45p, 49p, 50p, 62p 수정 (페이지 추가)_신규 12p		

연락처

VISION 담당 방문 수

TEL: 757-9340 FAX: 774-1039

-매뉴얼의 첫장에 이 서식을 작성해주세요-